

Canon

SPEEDLITE
600EX-RT

SPEEDLITE
600EX



Canon

600EX-RT
SPEEDLITE

600EX
SPEEDLITE

English

Français

Español

INSTRUCTION MANUAL
MODE D'EMPLOI
MANUAL DE INSTRUCCIONES

Introduction

The Canon Speedlite 600EX-RT/600EX is a high-output, multi-feature flash unit for Canon EOS cameras, compatible with E-TTL II, E-TTL and TTL autoflash and external flash metering systems. The Speedlite can be used as an on-camera flash that attaches to the hot shoe of the camera (normal shooting), and as a master unit or slave unit during wireless shooting. In addition to these three functions, the Speedlite also has dust and water resistance equivalent to EOS-1D series cameras.

Note that the 600EX-RT is equipped with a wireless flash shooting function that uses either radio transmission or optical transmission. The 600EX is equipped with a wireless flash shooting function that uses optical transmission only.

- **Read this instruction manual while also referring to your camera's instruction manual.**

Before using the Speedlite, read this instruction manual and your camera's instruction manual to familiarize yourself with the Speedlite operations.

Using the Speedlite with a Camera

- **Using with an EOS digital camera (Type-A camera)**
 - You can use the Speedlite for easy autoflash shooting in the same way as a camera's built-in flash.
- **Using with an EOS film camera**
 - **When using with an EOS film camera compatible with E-TTL II and E-TTL autoflash systems (Type-A camera),** you can use the Speedlite for easy autoflash shooting in the same way as a camera's built-in flash.
 - **When using the Speedlite with an EOS film camera compatible with TTL autoflash system (Type-B camera),** see page 116.







* **This instruction manual assumes that the Speedlite is used with an Type-A camera.**

Chapters

| | | |
|----------|--|-----|
| | Introduction | 2 |
| 1 | Getting Started and Basic Operations Flash preparations and basic flash shooting | 13 |
| 2 | Advanced Flash Shooting Advanced shooting using the flash shooting functions | 21 |
| 3 | Setting Flash Functions with Camera Operations Setting the flash functions from the camera's menu screen | 41 |
| 4 | Wireless Flash Shooting: Radio Transmission Wireless flash shooting with radio transmission | 47 |
| 5 | Wireless Flash Shooting: Optical Transmission Wireless flash shooting with optical transmission | 75 |
| 6 | Customizing the Speedlite Customizing with Custom Functions and Personal Functions | 91 |
| 7 | Reference System map, FAQ, use with a type-B camera | 103 |

 **When using a Speedlite 600EX, which does not have a radio transmission function, wireless shooting described in Chapter 4 is not available.** To shoot with wireless flash, see Chapter 5.

Contents

| | |
|---|-----------|
| Introduction | 2 |
| Chapters | 3 |
| Nomenclature..... | 6 |
| Conventions Used in this Manual | 12 |
| 1 Getting Started and Basic Operations | 13 |
| Installing the Batteries..... | 14 |
| Attaching and Detaching the Flash | 15 |
| Turning on the Power..... | 16 |
| Fully Automatic Flash Shooting | 18 |
| Using E-TTL II and E-TTL Autoflash in the Shooting Modes | 19 |
| 2 Advanced Flash Shooting | 21 |
|  Flash Exposure Compensation..... | 22 |
|  FEB | 23 |
| FEL: FE Lock..... | 24 |
|  High-speed Sync | 25 |
|  Second-curtain Sync | 26 |
| Bounce | 27 |
| Zoom: Flash Coverage Setting | 29 |
| M: Manual Flash..... | 31 |
| MULTI: Stroboscopic Flash..... | 33 |
| Ext.A/Ext.M: Flash External Metering | 36 |
| Modeling Flash..... | 38 |
| Clearing Speedlite Settings..... | 38 |
|  Color Filter..... | 39 |
| 3 Setting Flash Functions with Camera Operations | 41 |
| Flash Control from Camera's Menu Screen..... | 42 |
| 4 Wireless Flash Shooting: Radio Transmission | 47 |
|  Radio Transmission Wireless Flash Shooting..... | 48 |
| Wireless Settings | 52 |
| ETTL: Fully Automatic Wireless Flash Shooting..... | 57 |

| | |
|--|------------|
| ETTL : Wireless Multiple Flash Shooting with Flash Ratio | 61 |
| M : Wireless Multiple Flash Shooting with Manual Flash Output | 64 |
| Gr : Shooting with a Different Flash Mode for Each Group | 65 |
| Test Flash and Modeling Flash from a Slave Unit | 67 |
| Remote Release from a Slave Unit..... | 68 |
| Linked Shooting with Radio Transmission | 70 |
| 5 Wireless Flash Shooting: Optical Transmission | 75 |
| ⚡ Optical Transmission Wireless Flash Shooting..... | 76 |
| Wireless Settings | 78 |
| ETTL : Fully Automatic Wireless Flash Shooting..... | 81 |
| ETTL : Wireless Multiple Flash Shooting with Flash Ratio | 85 |
| M : Wireless Multiple Flash Shooting with Manual Flash Output | 88 |
| Manual Flash/Stroboscopic Flash Setting on a Slave Unit | 89 |
| 6 Customizing the Speedlite | 91 |
| C.Fn / P.Fn: Setting Custom and Personal Functions | 92 |
| C.Fn: Setting Custom Functions | 95 |
| P.Fn: Setting Personal Functions | 101 |
| 7 Reference | 103 |
| 600EX-RT/600EX System..... | 104 |
| Flash Firing Restriction due to Temperature Increase | 106 |
| Troubleshooting Guide | 107 |
| Specifications | 112 |
| Using with a Type-B Camera | 116 |
| Index | 120 |

Nomenclature

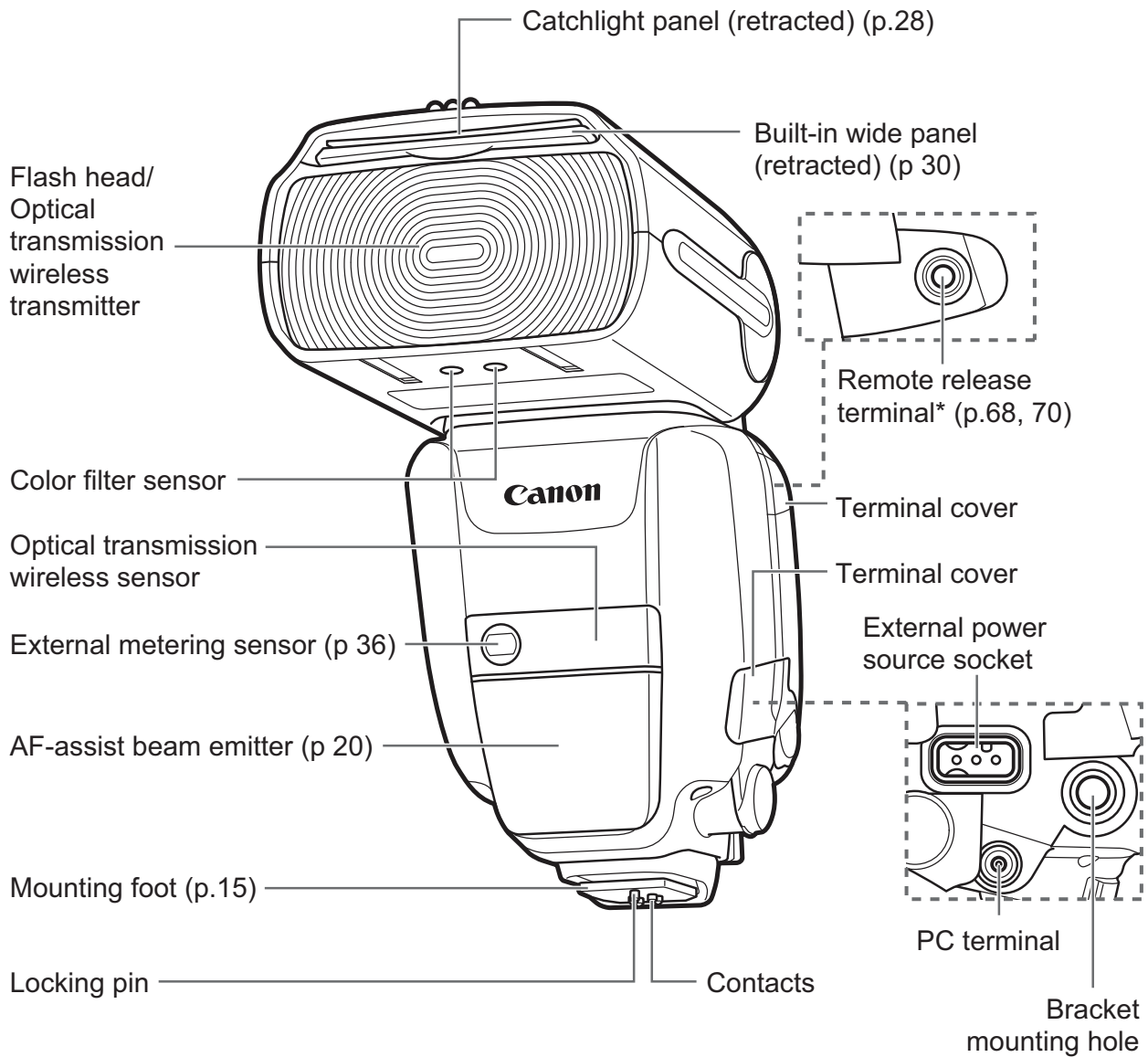

* Not provided on Speedlite 600EX. (Do not function.)

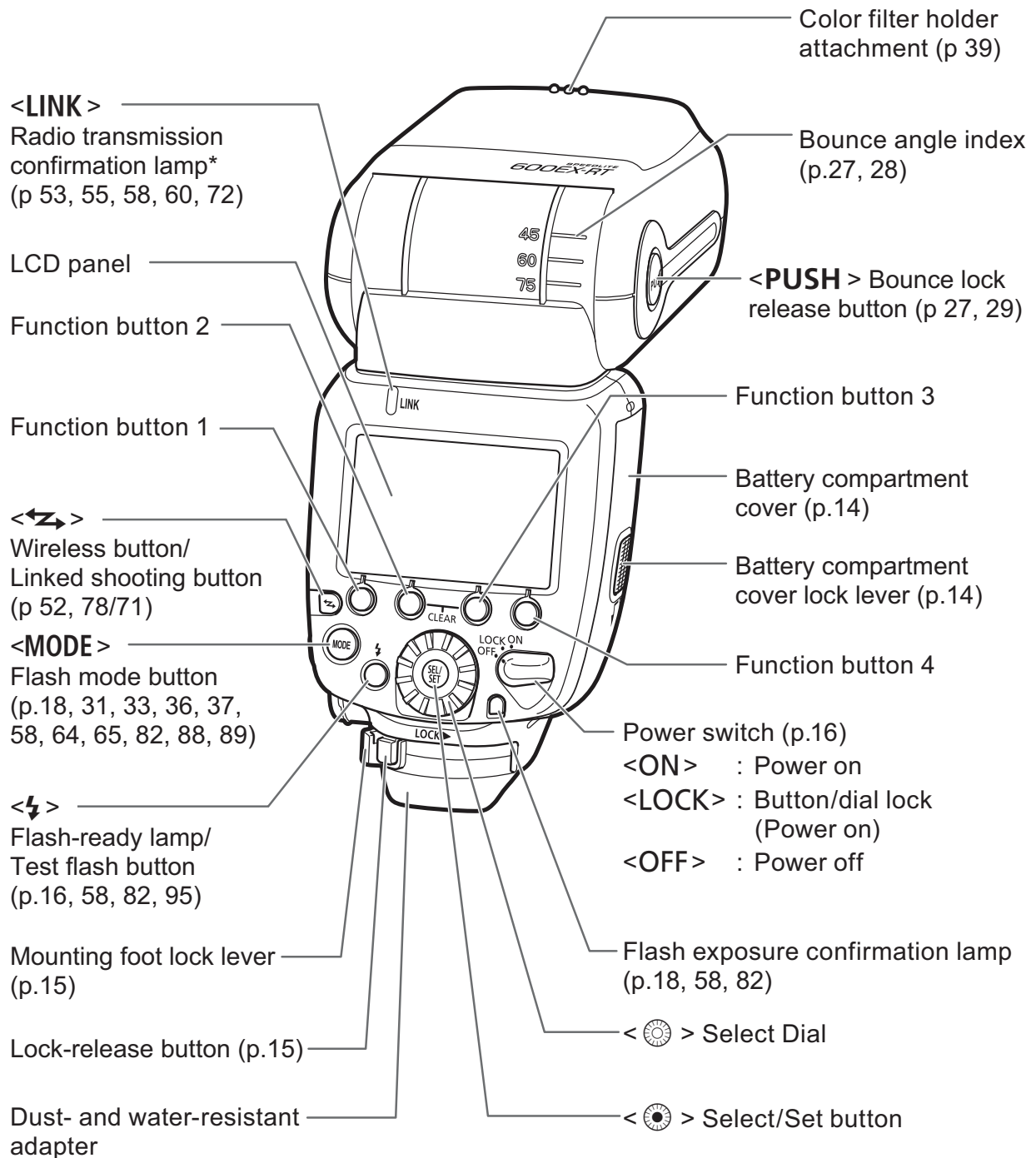

LCD panel

E-TTL II/E-TTL/TTL autoflash (p.19)

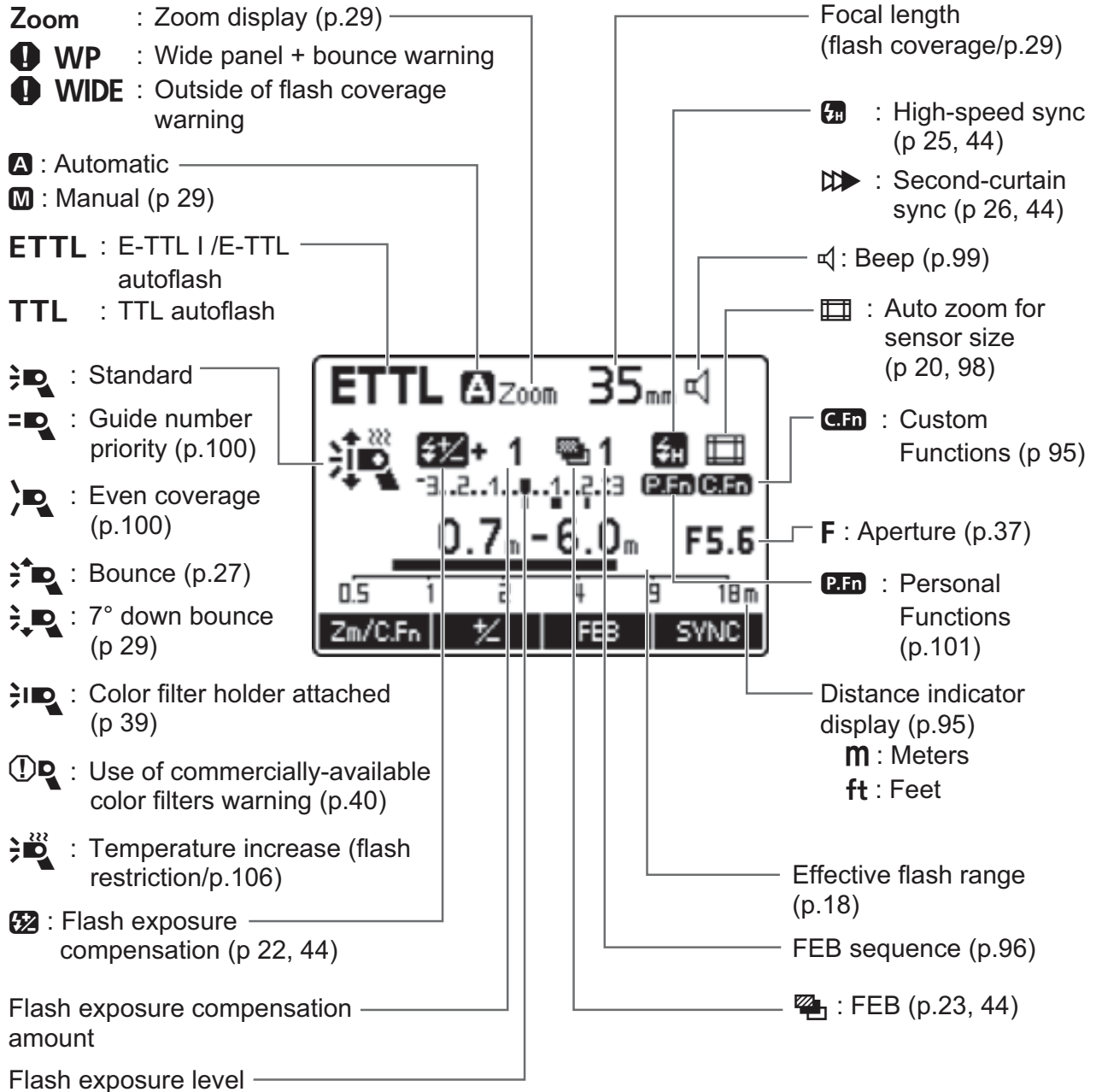

- The display will show only the settings currently applied.
- The functions displayed above function buttons 1 to 4, such as < **Zm/C.Fn** > and < **±** >, change according to settings' status.
- When a button or dial is operated, the LCD panel illuminates (p.17).

Manual flash (p.31)

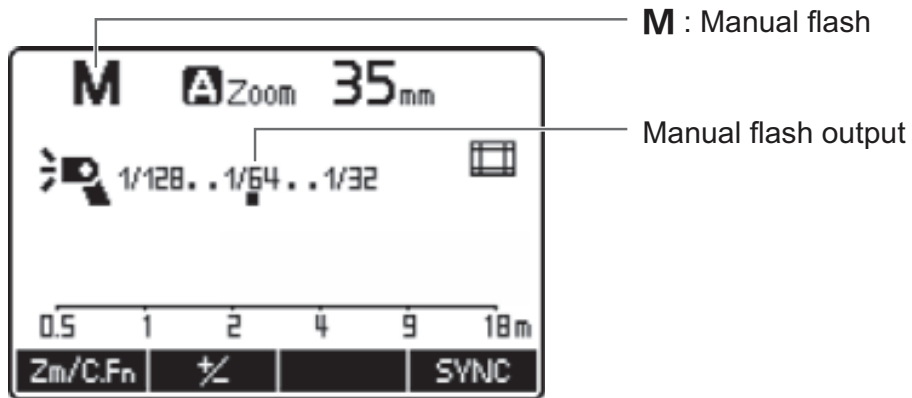

Stroboscopic flash (p.33)

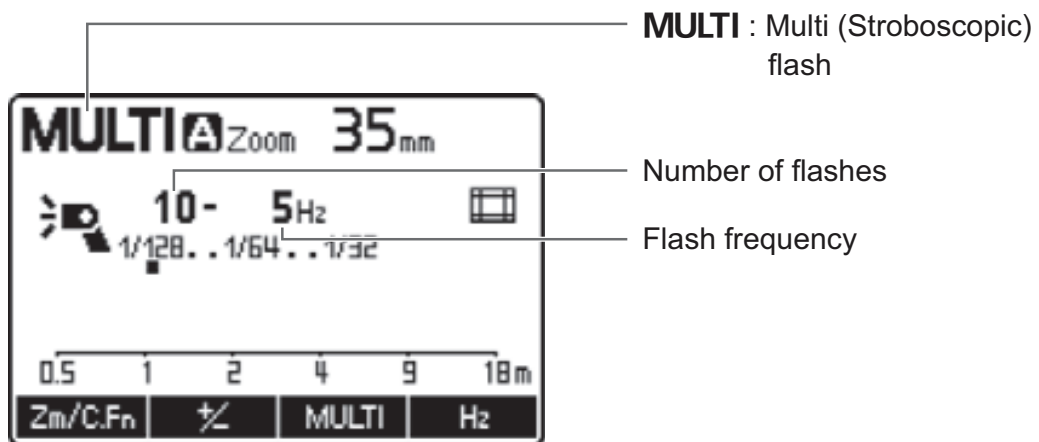

Auto/manual external flash metering (p.36/37)

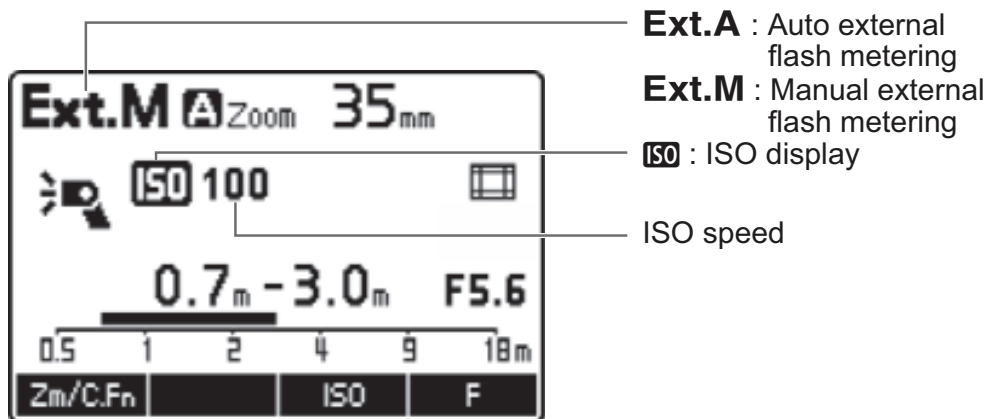

Radio transmission wireless shooting/optical transmission wireless shooting (p.47/75)

● Master unit

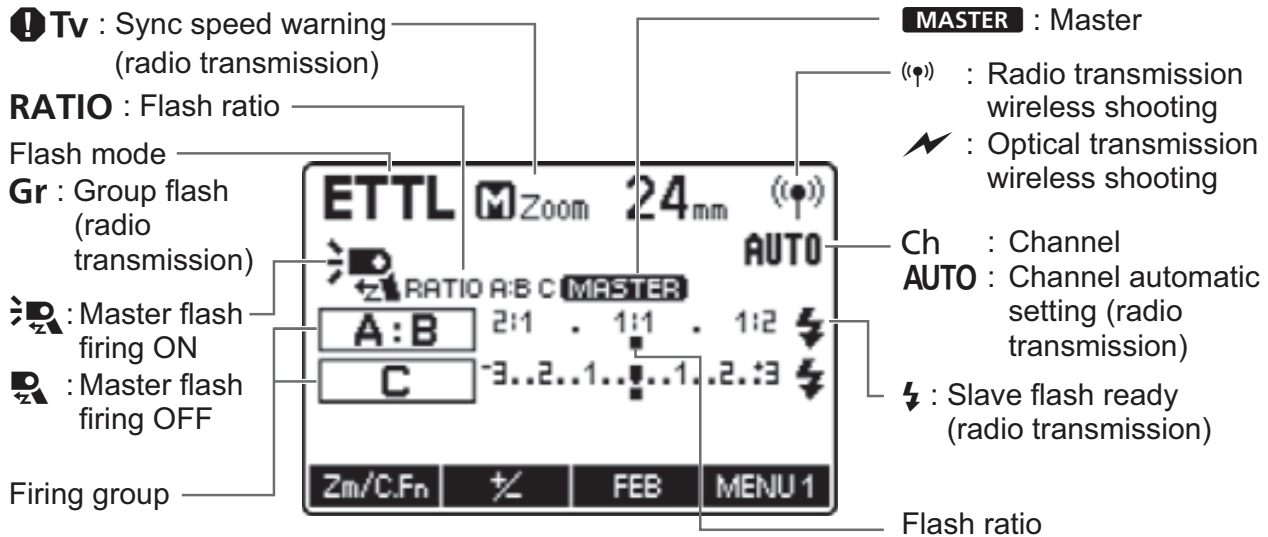

● Slave unit

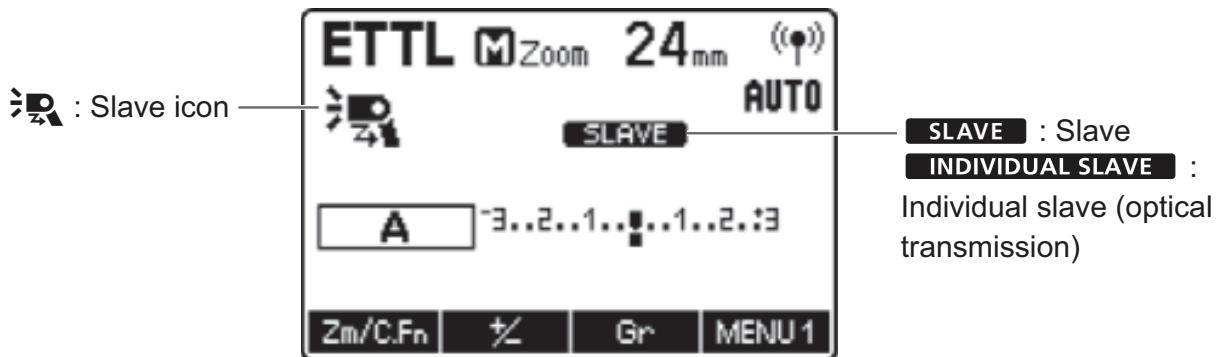

Linked shooting (p.70)

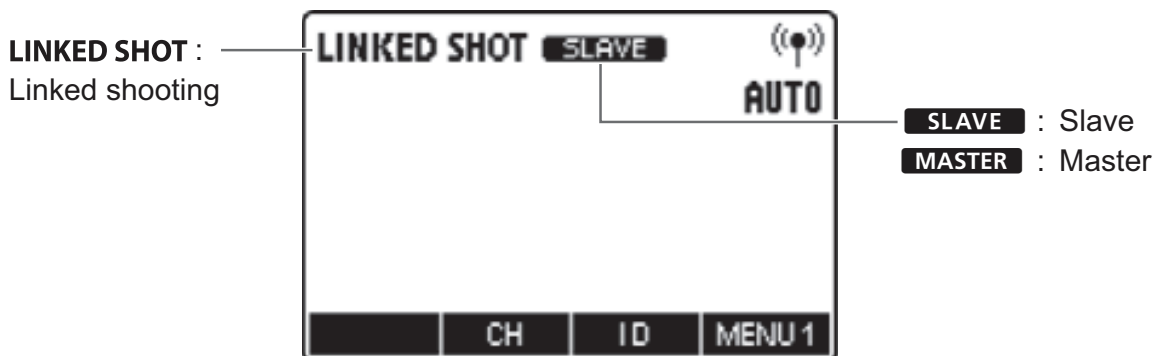

Accessories provided

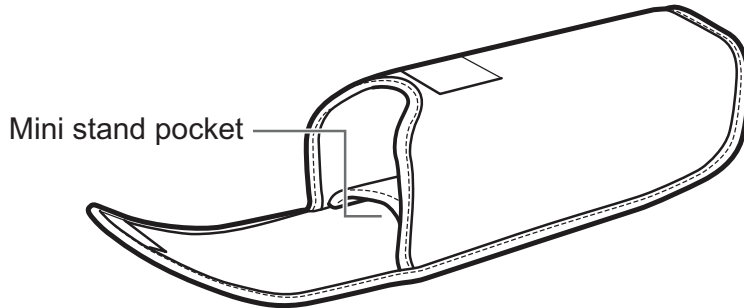

Speedlite case

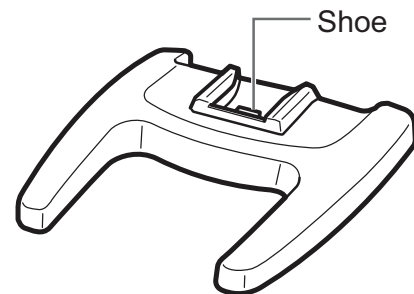

Mini stand
(p.48, 76)

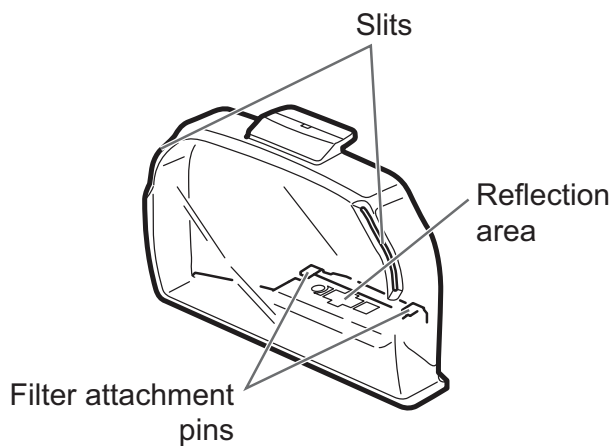

Color filter holder
SCH-E1
(p.39)

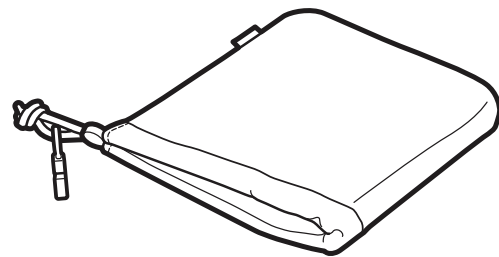

Color filter holder case

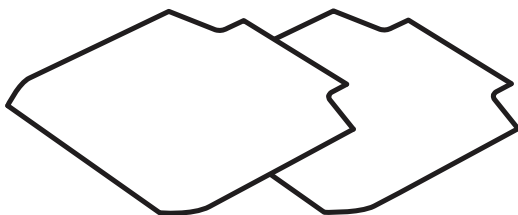



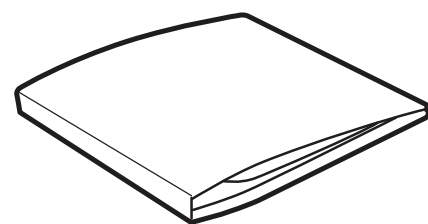



Color filter set
SCF-E1
(2 types/p.39)



Color filter case

Conventions Used in this Manual

Icons in this Manual

-  : Indicates the selection dial.
-  : Indicates the select/set button.
- 4 / 6 / 16 : Indicates that the respective function remains active for 4 sec., 6 sec. or 16 sec. after you let go of the button.
- (p.**) : Reference page numbers for more information.
-  : Warning to prevent shooting problems.
-  : Supplemental information.

Basic Assumptions

- The operation procedures assume that both the camera and the Speedlite's power switches are already set to <ON>.
- The icons used for buttons, dials and symbols in the text match the icons found on the camera and the Speedlite.
- The operation procedures assume that the menu and Custom Functions of the camera and the Custom Functions and Personal Functions of the Speedlite are at their default settings.
- All figures are based on the use of four AA/LR6 alkaline batteries and Canon's testing standards.
- For explanatory purposes, the illustrations show the Speedlite 600EX-RT.

1

Getting Started and Basic Operations

This chapter describes the preparations before starting flash shooting and the basic shooting operations.



Cautions for firing continuous flashes

- To avoid degrading and damaging the flash head due to overheating, do not fire more than 20 continuous flashes. After 20 continuous flashes, allow a rest time of at least 10 min.
- If you fire more than 20 continuous flashes, and then fire the flash again repeatedly in short intervals, the safety function may activate and restrict flash firing. While flash firing is restricted, the recycling time is automatically set to an interval between approx. 8 and 20 sec. If this happens, allow a rest time of at least 15 min.
- For details, see “Flash Firing Restriction due to Temperature Increase” on page 106.

Installing the Batteries

Install four AA/LR6 batteries.

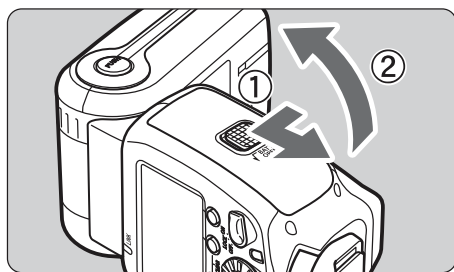

1 Open the cover.

- Slide the lock lever to the left as shown in ①, slide the cover down, and open the battery compartment cover.

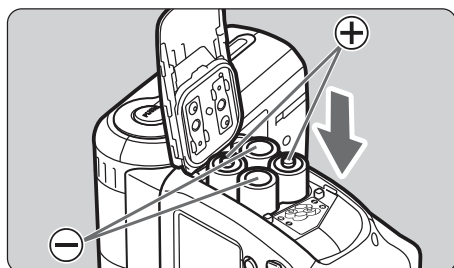

2 Install the batteries.

- Make sure the + and – battery contacts are correctly oriented as shown in the battery compartment.
- The grooves on the side surfaces of the battery compartment indicate –. This is convenient when replacing the batteries in a dark place.

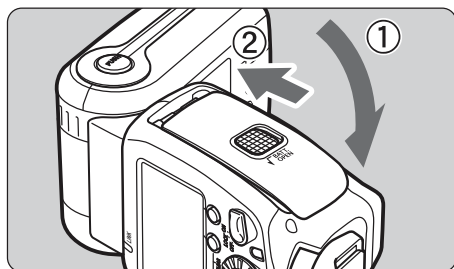

3 Close the cover.

- Close the battery compartment cover and slide it up.
- ▶ When it clicks in place, the battery compartment cover is locked.

Recycling Time and Number of Flashes

| Recycling Time | | Number of Flashes |
|-------------------------|-------------------------|----------------------------|
| Quick Flash | Normal Flash | |
| Approx. 0.1 to 3.3 sec. | Approx. 0.1 to 5.5 sec. | Approx. 100 to 700 flashes |

- Based on new AA/LR6 alkaline batteries and Canon's testing standards.
- The Quick Flash function enables flash shooting before the flash is fully charged (p.16).



- Using AA/LR6 batteries other than the alkaline type may cause improper battery contact due to the irregular shape of the battery contacts.
- If you change the batteries after firing flashes continuously, be aware that the batteries might be hot.



- When  is displayed, replace the batteries with new ones.
- Use a new set of four batteries of the same brand. When replacing the batteries, replace all four at one time.
- AA/LR6 rechargeable Ni-MH or lithium batteries can also be used.

Attaching and Detaching the Flash

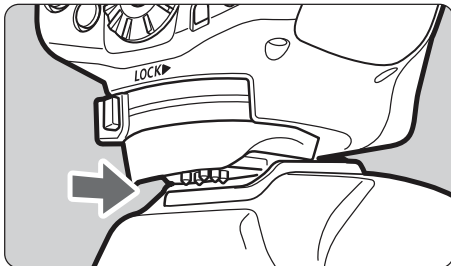

1 Attach the Speedlite.

- Slip the Speedlite's mounting foot **all the way** into the camera's hot shoe.

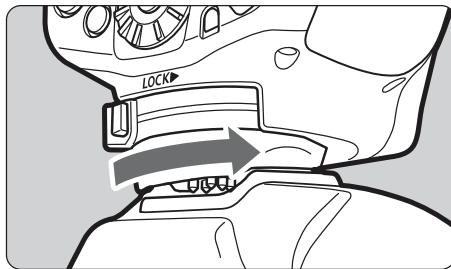

2 Secure the Speedlite.

- On the mounting foot, slide the lock lever to the right.
- ▶ When the lock lever clicks in place, it will be locked.

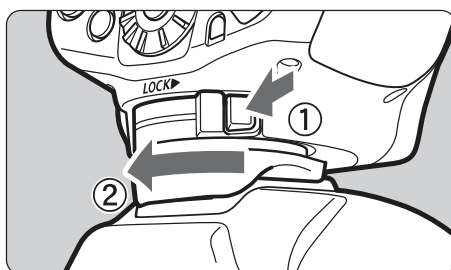

3 Detach the Speedlite.

- While pressing the lock-release button, slide the lock lever to the left and detach the Speedlite.



Before attaching or detaching the Speedlite, be sure to turn off the Speedlite.

Turning on the Power

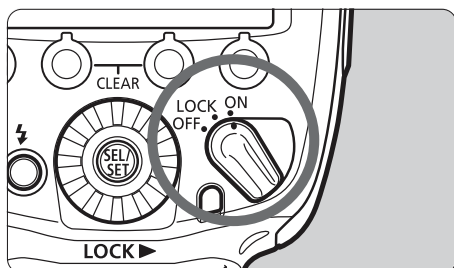

1 Set the power switch to <ON>.

- ▶ The flash recycling starts.

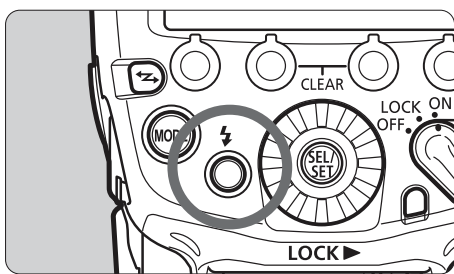

2 Check that the flash is ready.

- The flash-ready lamp changes in order from **off** to **green** (Quick Flash ready) to **red** (fully charged).
- Press the flash-ready lamp (test flash button) to fire a test flash.

About Quick Flash

The Quick Flash function enables flash shooting while the flash-ready lamp is green (before the flash is fully charged).

The guide number is 1/2 to 1/6 of the full output, but it is useful for shooting with a faster recycling time at a short shooting distance.

Set the drive mode to single shooting. You cannot use Quick Flash when continuous shooting, FEB, manual flash or stroboscopic flash is set.

About Auto Power Off

To save battery power, the power will turn off automatically after approx. 90 sec. of idle use. To turn on the Speedlite again, press the camera's shutter button halfway, or press the test flash button (flash-ready lamp). During radio transmission wireless master flash shooting (p.59) or during linked shooting (p.73), the time until auto power off takes effect is 5 min.



Quick Flash cannot be used when the flash mode is set to <TTL>.

About the Lock Function

By setting the power switch to <LOCK>, you can disable flash's button and dial operations. Use this to prevent the flash function settings from being accidentally changed after you set them.

If you operate a button or dial, <LOCKED> is displayed on the LCD panel (the functions displayed above function buttons 1 to 4, such as <Zm/C.Fn> and <⚡>, are not displayed).

About the LCD Panel Illumination

When a button or dial is operated, the LCD panel illuminates for 12 sec. When setting a function, the illumination continues until the setting is complete.

During normal flash shooting, wireless master flash shooting and master linked shooting, the LCD panel illuminates in green. If the Speedlite is a slave unit, it illuminates in orange.



- You cannot use the test flash while the camera's 4/6/16 timer is operating.
- The flash settings are stored even when the power is turned off. To retain the settings when replacing the batteries, replace the batteries within 1 min. of turning off the power switch and removing the batteries.
- When the temperature of the flash head has risen due to continuous flash firing, the time until auto power off takes effect may increase.
- You can fire a test flash while the power switch is set to the <LOCK> position. Also, when a button or dial is operated, the LCD panel illuminates.
- You can set a beep to sound when the Speedlite is fully charged (C.Fn-20/p.99).
- You can enable the (Quick) flash to fire when the flash-ready lamp is lit green during continuous shooting (C.Fn-06/p.97).
- Auto power off can be disabled (C.Fn-01/p.95).
- You can change the duration of the LCD panel illumination (C.Fn-22/p.100).
- You can change the color of the LCD panel illumination (P.Fn-02 to 04/p.101).

Fully Automatic Flash Shooting

When you set the camera's shooting mode to <P> (Program AE) or Full Auto, you can shoot in E-TTL II/E-TTL fully automatic flash mode.

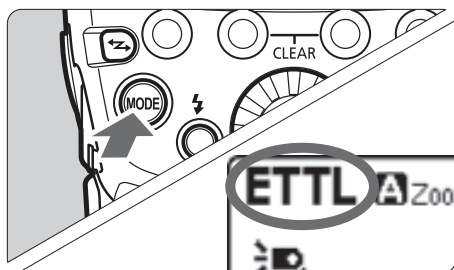

1 Set the flash mode to <E-TTL>.

- Press the <MODE> button and set to <E-TTL>.
- Check that <MASTER> or <SLAVE> is not displayed.



2 Focus the subject.

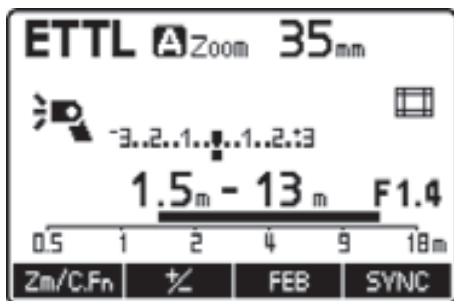

- Press the shutter button halfway to focus.
- ▶ The shutter speed and aperture are displayed in the viewfinder.
- Check that <⚡> is lit in the viewfinder.

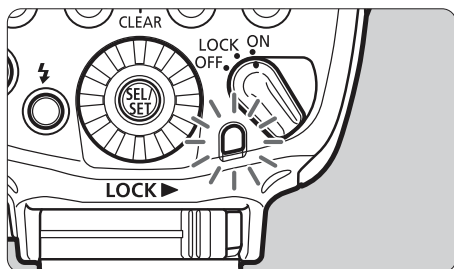

3 Take the picture.

- Check that the subject is in the effective flash range.
- When you press the shutter button completely, the flash will fire and the picture will be taken.
- ▶ If a standard flash exposure was obtained, the flash exposure confirmation lamp lights for 3 sec.



- Even when attached to a camera that supports E-TTL II autoflash system, <E-TTL> is displayed on the LCD panel.
- If the flash exposure confirmation lamp does not light or if the subject is dark (underexposed) when you check the image on the camera's LCD monitor, move closer to the subject and shoot again. You can also increase the ISO speed when using a digital camera.
- "Full Auto" refers to <A+>, <□>, and <CA> shooting modes.

Using E-TTL II and E-TTL Autoflash in the Shooting Modes

Just set the camera's shooting mode to <Tv> (Shutter-priority AE), <Av> (Aperture-priority AE), or <M> (Manual exposure) and you can use E-TTL II/E-TTL autoflash.

| | |
|-----------|---|
| Tv | <p>Select this mode when you want to set the shutter speed manually. The camera will then automatically set the aperture matching the shutter speed to obtain a standard exposure.</p> <ul style="list-style-type: none"> ● If the aperture display blinks, it means that the background exposure will be underexposed or overexposed. Adjust the shutter speed until the aperture display stops blinking. |
| Av | <p>Select this mode when you want to set the aperture manually. The camera will then automatically set the shutter speed matching the aperture to obtain a standard exposure. If the background is dark, such as in a night scene, a slow sync speed will be used to obtain a standard exposure of both the main subject and background. Standard exposure of the main subject is obtained with the flash, while a standard exposure of the background is obtained with a long exposure using a slow shutter speed.</p> <ul style="list-style-type: none"> ● Since a slow shutter speed will be used for low-light scenes, using a tripod is recommended. ● If the shutter speed display blinks, it means that the background exposure will be underexposed or overexposed. Adjust the aperture until the shutter speed display stops blinking. |
| M | <p>Select this mode if you want to set both the shutter speed and aperture manually. Standard exposure of the main subject is obtained with the flash. The exposure of the background is obtained with the shutter speed and aperture combination you set.</p> |

- If you use the <DEP> or <A-DEP> shooting mode, the result will be the same as using the <P> (Program AE) mode.

Flash Sync Speeds and Apertures Used

| | Shutter Speed | Aperture |
|-----------|--|-----------|
| P | Set automatically (1/X sec. - 1/60 sec.) | Automatic |
| Tv | Set manually (1/X sec. - 30 sec.) | Automatic |
| Av | Set automatically (1/X sec. - 30 sec.) | Manual |
| M | Set manually (1/X sec. - 30 sec., Bulb) | Manual |

- 1/X sec. is the camera's maximum flash sync speed.

About Auto Zoom Adjustment to Image Sensor Size

EOS digital cameras have three sizes of image sensors, and the effective focal length of the mounted lens varies depending on the model. This flash automatically recognizes the image sensor size of each EOS digital camera, and automatically adjusts the optimum flash coverage for the effective focal length of the lens in a range of 20 to 200 mm.

When mounted on a supported camera,  is displayed on the LCD panel.



 Auto zoom adjustment for image sensor size can be disabled (C.Fn-09/p 98).

About Color Temperature Information Transmission

This function optimizes the white balance during flash shooting by transmitting the color temperature information to the EOS digital camera when the flash fires. When you set the camera's white balance to **<AWB>** or **<⚡>**, the function is enabled automatically.

See the Specifications in your camera's instruction manual to find out if it is compatible with this function.

About AF-Assist Beam

When autofocus cannot achieve focus on the subject in low-light or when contrast is low, the built-in AF-assist beam activates automatically to help autofocus. The AF-assist beam in 600EX-RT/600EX is compatible with all EOS cameras' AF points. The AF-assist beam is compatible with 28mm and longer focal lengths and its effective range is shown in the table below.

| Position | Effective Range (Approx. m/ft.) |
|-----------|---------------------------------|
| Center | 0.6 / 2.0 to 10 / 32.8 |
| Periphery | 0.6 / 2.0 to 5 / 16.4 |

2

Advanced Flash Shooting

This chapter describes advanced shooting operations using the flash functions.



 When the camera's shooting mode is set to a fully automatic mode or an Image Zone mode, the operations other than "Bounce" (p.27, 29), "Wide Panel" (p.30) and "Color Filters" (p.39) in this chapter are not available. Set the camera's shooting mode to **P/Tv/Av/M/B** (Creative Zone mode) to enable all the operations in this chapter.

Flash Exposure Compensation

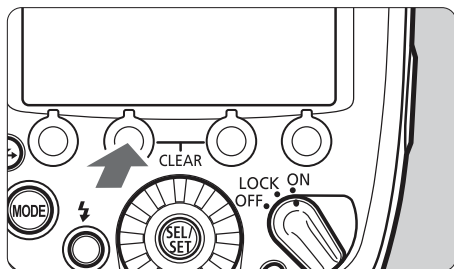
In the same way as normal exposure compensation, you can set exposure compensation for flash. The flash exposure compensation amount can be set up to ± 3 stops in 1/3-stop increments.



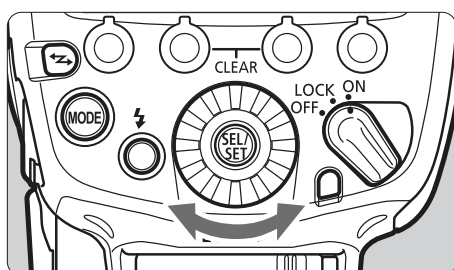

1 Press the button.

- Press function button 2 .
- ▶  is displayed and the flash exposure compensation amount is highlighted.



2 Set the flash exposure compensation amount.

- Turn  to set the flash exposure compensation amount, and press .
- ▶ The flash exposure compensation amount is set.
- “0.3” indicates 1/3 stops and “0.7” indicates 2/3 stops.
- To cancel flash exposure compensation, return the compensation amount to “ ± 0 ”.



- Generally, set an increased exposure compensation for bright subjects and set a decreased exposure compensation for dark subjects.
- If the camera's exposure compensation is set to 1/2-stop increments, flash exposure compensation will be up to ± 3 stops in 1/2-stop increments.
- When the flash exposure compensation is set on both the flash and the camera, the flash setting is given priority.
- The flash exposure compensation amount can be set directly with  without pressing the button (C.Fn-13/p.99).

FEB

You can take three shots while automatically changing the flash output. This is called FEB (Flash Exposure Bracketing). The settable range is up to ± 3 stops in 1/3-stop increments.

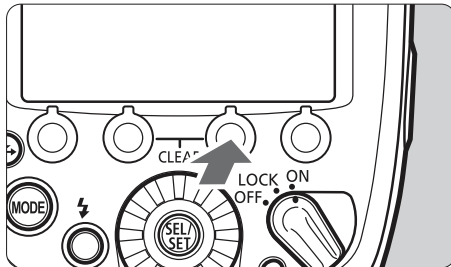

1 Press the **< FEB >** button.

- Press function button 3 **< FEB >**.
- ▶ **< FEB >** is displayed and the FEB level display is highlighted.

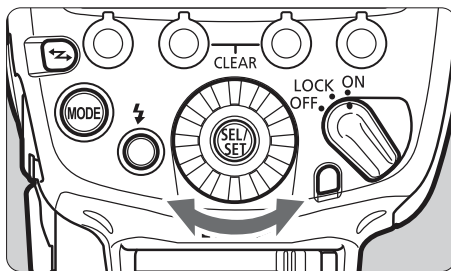

2 Set the FEB level.

- Turn **< SEL/SET >** to set the FEB level, and press **< SEL/SET >**.
- ▶ The FEB level is set.
- “0.3” indicates 1/3 stops and “0.7” indicates 2/3 stops.
- When used together with flash exposure compensation, FEB shooting is performed based on the flash exposure compensation amount. When the FEB range exceeds ± 3 stops, the end of the flash exposure level shows **< ◀ >** or **< ▶ >**.



- After the three shots are taken, FEB is canceled automatically.
- Before shooting with FEB, it is recommended to set the camera's drive mode to single shooting and check that the flash is recycled.
- You can use FEB together with flash exposure compensation or FE lock.
- If the camera's exposure compensation is set to 1/2-stop increments, flash exposure compensation will be up to ± 3 stops in 1/2-stop increments.
- You can set FEB to remain enabled after shooting the three shots (C.Fn-03/p.96).
- You can change the FEB shooting sequence (C.Fn-04/p.96).

FEL: FE Lock

FE (Flash Exposure) lock locks the correct flash exposure setting for any part of the scene.

While <ETTL> is displayed on the LCD panel, press the camera's <M-Fn> button. On cameras without a <M-Fn> button, press the <FEL> or <✕> (AE lock) button.

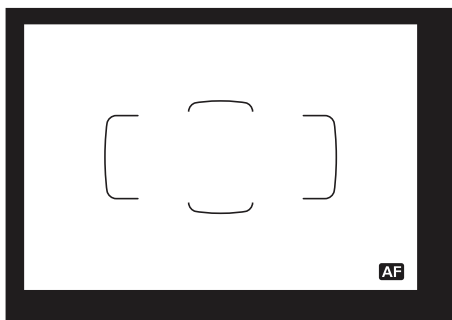

1 Focus the subject.

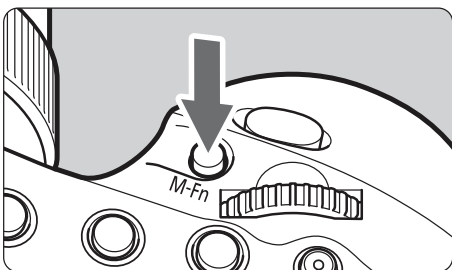

2 Press the <M-Fn> button. (Ⓜ16)

- Aim the center of the viewfinder over the subject and press the <M-Fn> button.
- ▶ The Speedlite fires a preflash, and the flash output required for the subject is retained in the memory.
- ▶ “FEL” will be displayed in the viewfinder for 0.5 sec.
- Each time you press the <M-Fn> button, a preflash will be fired and the new flash output required at that time is retained in the memory.



- If a correct exposure cannot be obtained when FE lock is performed, <⚡> blinks in the viewfinder. Move closer to the subject, open the aperture, and perform FE lock again. You can also increase the ISO speed and perform FE lock again when using a digital camera.
- If the target subject is too small in the viewfinder, FE lock might not be very effective.

High-speed Sync

With high-speed sync, the flash can synchronize with all shutter speeds. This is convenient when you want to use aperture-priority AE for fill-flash portraits of a subject.

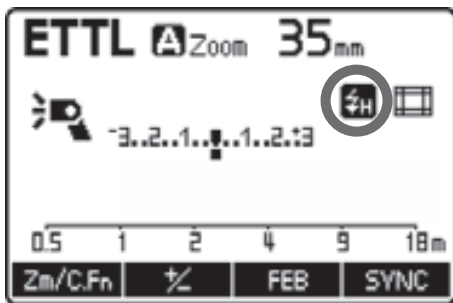
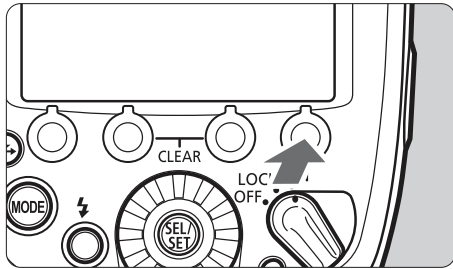

Display .

- Press function button 4 < **SYNC** > to display .
- Check that is lit in the viewfinder.



- When using the flash with EOS cameras compatible with E-TTL and released up to 2011, high-speed sync is not possible with radio transmission wireless flash shooting (p.51).
- With high-speed sync, the faster the shutter speed, the shorter the effective flash range will be. Check the effective flash range on the LCD panel.



- If you set a shutter speed that is equal to or slower than the camera's maximum flash sync speed, will not be displayed in the viewfinder.
- To return to normal flash shooting, press function button 4 < **SYNC** > to turn off .
- High-speed sync is not available during stroboscopic flash.

▶▶ Second-curtain Sync

Shooting with a slow shutter speed and second-curtain sync captures the trajectory of moving light sources, such as car lights, in a natural way. The flash fires right before the exposure finishes (shutter closes).

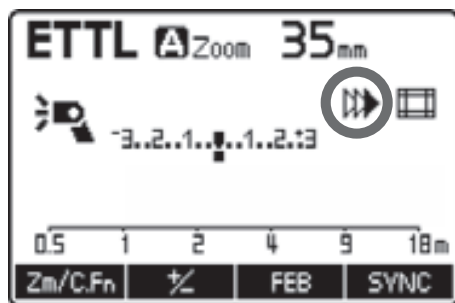
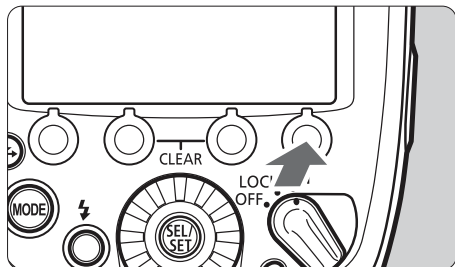

Display <▶▶>.

- Press function button 4 < **SYNC** > to display <▶▶>.



- Second-curtain sync works well when the camera's shooting mode is set to "buLb".
- To return to normal flash shooting, press function button 4 < **SYNC** > to turn off <▶▶>.
- When the flash mode is set to <ETTL>, the flash fires twice. This first flash is a preflash to determine the flash output. It is not a malfunction.
- Second-curtain sync is not available during wireless flash shooting.

Bounce

By pointing the flash head toward a wall or ceiling, the flash will bounce off the surface before illuminating the subject. This can soften shadows behind the subject for a more natural-looking shot. This is called bounce flash.

Set the Bounce Direction

- You can turn (bounce) the flash head while pressing the **<PUSH>** button as shown. During bounce shooting, the flash icon on the LCD panel changes to .
- When the flash head is turned while the flash coverage is set to **<A>** (automatic) (p.29), the flash coverage is fixed at 50 mm and **<--->** is displayed on the LCD panel.
- You can also set the flash coverage manually (p.29).

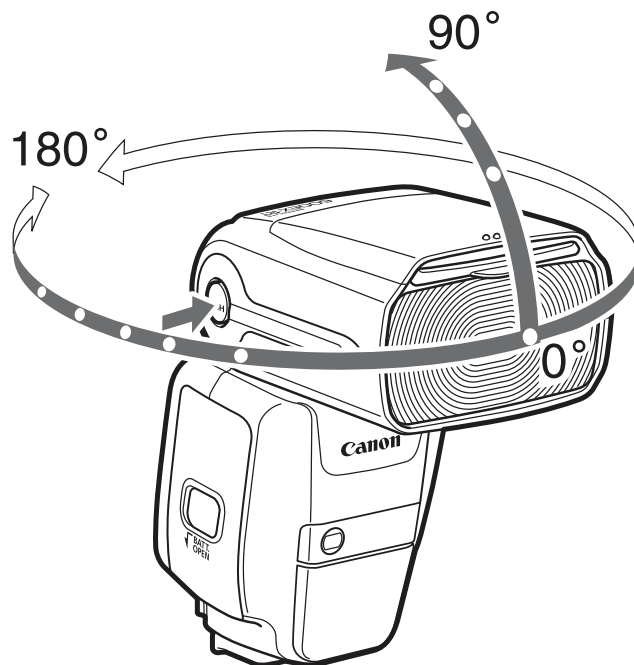

- If the wall or ceiling is too far away, the bounced flash might be too weak and result in underexposure.
- If the picture appears dark or the flash exposure confirmation lamp does not light, use a larger aperture opening (smaller f/number) and try again. You can also increase the ISO speed when using a digital camera.
- The wall or ceiling should be plain white for high reflectance. If the bounce surface is not white, a color cast may result in the picture.

Catchlight Panel

Using the catchlight panel enables you to reflect light in a person's eyes and create a more vivid expression.

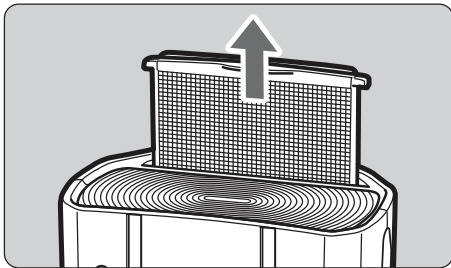

1 Turn the flash head 90° up.

2 Pull out the wide panel.

- Pull up the wide panel.
- ▶ The catchlight panel is also pulled up at the same time.

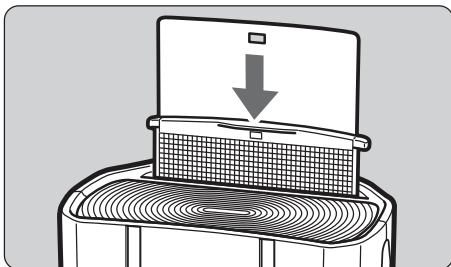

3 Push back the wide panel.

- Push back the wide panel.
- Shoot using the same method as bounce shooting.

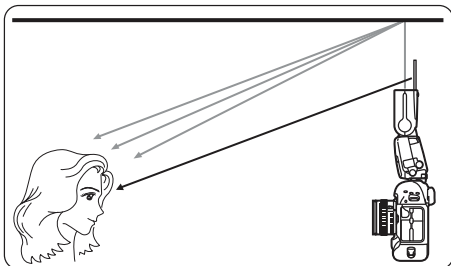

- Position the flash head towards the front and 90° up. When the flash head is rotated to the left or right, the catchlight is not very effective.
- To effectively obtain the catchlight in a person's eyes, shoot within 1.5 m (4.9 ft.) of the subject.

Short Distance Flash Shooting

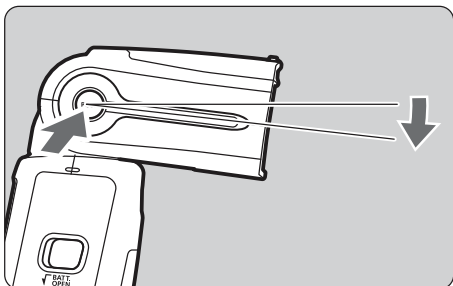

When you position the flash head down by 7° while pressing the **<PUSH>** button, you can shoot subjects at a short distance in a range of approx. 0.5 to 2 m (1.6 to 6.6 ft.).

When the flash head is positioned down by 7°, the flash icon on the LCD panel changes to .

Zoom: Flash Coverage Setting

“Automatic” and “Manual” settings are available as the flash coverage settings. In the auto setting, the flash coverage is automatically adjusted according to the focal length of the shooting lens. With the manual setting, you can set any flash coverage in a range of 20 to 200 mm.

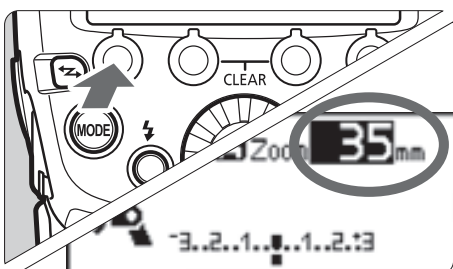

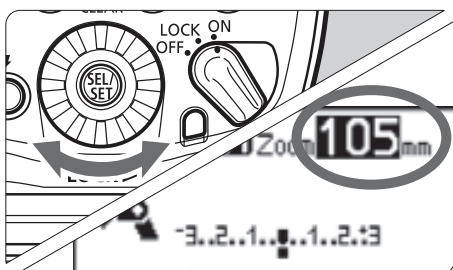

1 Press the **<Zm/C.Fn>** button.

- Press function button 1 **<Zm/C.Fn>**.
- ▶ The flash coverage value is highlighted.



2 Set the flash coverage.

- Turn  to set the flash coverage, and press .
- **<A>** indicates the automatic setting and **<M>** indicates the manual setting.



- When the flash coverage is set to manual, set a flash coverage that is wider than the angle of view you are shooting, to prevent the periphery of the picture from being darker.
- When a lens with a focal length inferior to 20 mm is mounted, the <ⓘ WIDE> warning is displayed on the LCD panel. When using a camera with a smaller image sensor size than full-frame, the <ⓘ WIDE> warning is displayed when the actual shooting angle of view is wider than the angle of view of the 20 mm lens.
- When shooting with the camera and Speedlite's PC terminal connected by a commercially-available sync cord, set the flash coverage manually.

Wide Panel

When you use the flash's built-in wide panel together, you can perform flash shooting with ultra-wide angle lenses up to 14 mm.

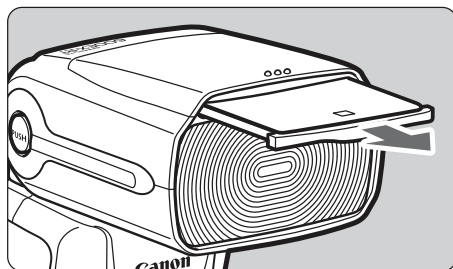

1 Pull out the wide panel.

- Pull out the wide panel.

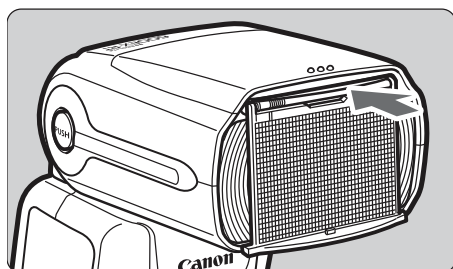

2 Push back the catchlight panel.



- EF15mm f/2.8 Fisheye and EF8-15mm f/4L Fisheye USM angles of view are not supported.
- You cannot set the flash coverage while using the wide panel.



- Since underexposure may occur, the <ⓘ WP> warning is displayed on the LCD panel when using the wide panel with bounce shooting.
- Pull out the wide panel gently. Using excessive force may detach the wide panel.

M: Manual Flash

You can set the flash output from 1/128 power to 1/1 full output in 1/3-stop increments.

Use a hand-held flash meter to determine the required flash output to obtain a correct flash exposure. Setting the camera's shooting mode to **<Av>** or **<M>** is recommended.

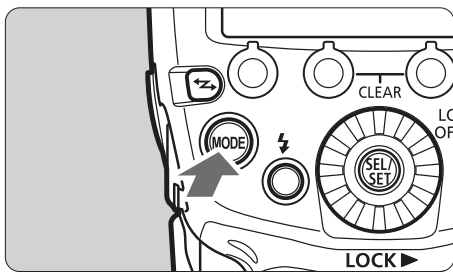

1 Set the flash mode to **<M>**.

- Press the **<MODE>** button and set to **<M>**.

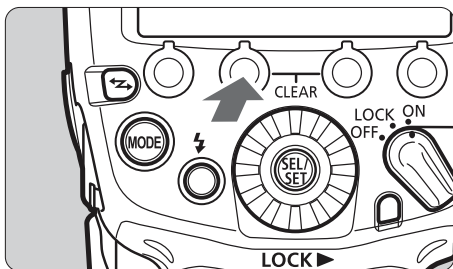
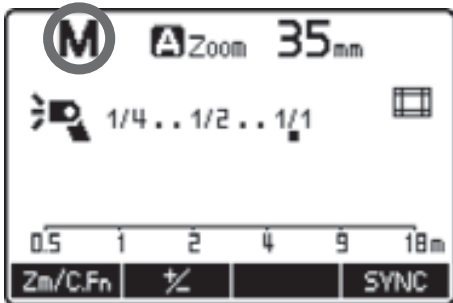

2 Set the flash output.

- Press function button 2 **< 1/2 >**.
- ▶ The flash output level is highlighted.
- Turn **< SEL/SET >** to set the flash output, and press the **< SEL/SET >** button.
- When you press the camera's shutter button halfway, the indication of shooting distance and the aperture setting are displayed.

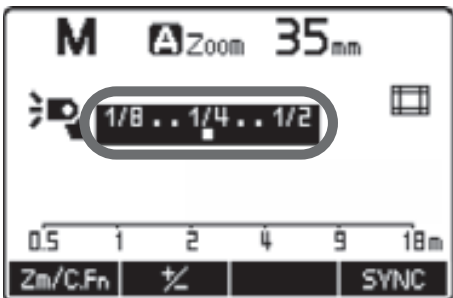

Metered Manual Flash Exposures

When the Speedlite is used with the EOS-1D series, you can also set the flash exposure level manually. This is convenient for shooting at a short distance from the subject. Use a commercially available 18% gray card and shoot as follows.

1 Set the camera and Speedlite settings.

- Set the camera's shooting mode to <M> or <Av>.
- Set the Speedlite's flash mode to <M>.

2 Focus the subject.

- Focus manually.

3 Set up an 18% gray card.

- Place the gray card at the subject's position.
- In the viewfinder, the entire spot metering circle at the center should cover the gray card.

4 Press the <M-Fn> or <FEL> button. (ⓘ16)

- ▶ The Speedlite will fire a preflash and the required flash output for the correct flash exposure is retained in memory.
- ▶ On the right side of the viewfinder, the exposure level indicator will show the flash exposure level for the standard exposure.

5 Set the flash exposure level.

- Adjust the Speedlite's manual flash level and the aperture so that the flash exposure level aligns with the standard exposure index.

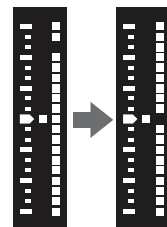

6 Take the picture.

- Remove the gray card and take the picture.



Metered manual flash exposure is only available with EOS-1D series cameras.

MULTI: Stroboscopic Flash

When using stroboscopic flash with a slow shutter speed, you can shoot multiple successive movements within a single picture, similar to stop-motion pictures.

In stroboscopic flash, set the flash output, number of flashes, and flash frequency (number of flashes per second = Hz). For the maximum number of continuous flashes, see page 35.

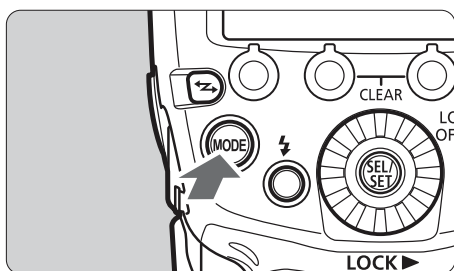

1 Set the flash mode to <MULTI>.

- Press the <MODE> button and set to <MULTI>.

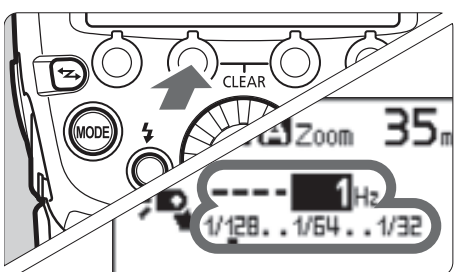
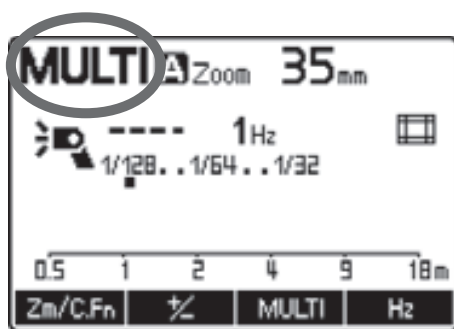

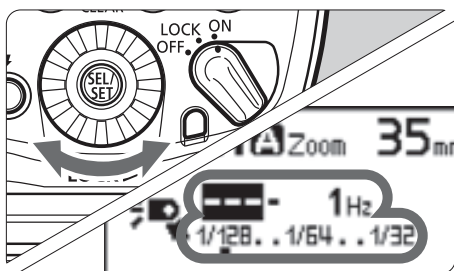

2 Select an item.

- Press the <  > function button for the flash output, press < **MULTI** > for the number of flashes, and press < **Hz** > for the flash frequency.
- ▶ You can set the item of the button you pressed.



3 Set the value.

- Turn <  > to set the value, and press the <  > button.
- Repeat steps 2 and 3 to set the flash output, number of flashes and flash frequency.

Calculating the Shutter Speed

In stroboscopic flash, to ensure that the shutter stays open until the end of the continuous flashes, set the camera with a shutter speed calculated with the following equation.

Number of flashes ÷ flash frequency = shutter speed

For example, if the number of flashes is set to 10 (times) and flash frequency to 5 (Hz), set the shutter speed to 2 sec. or longer.



- To avoid degrading and damaging the flash head due to overheating, do not shoot repeatedly with stroboscopic flash more than 10 times. After shooting 10 times, allow a rest time of at least 15 min.
- If you shoot repeatedly more than 10 times, the safety function may activate and restrict the flash firing. If this happens, allow a rest time of at least 15 min.



- Stroboscopic flash is most effective when combining a highly reflective subject with a dark background.
- Using a tripod, remote switch and external power source is recommended.
- Stroboscopic flash is not possible with 1/1 power or 1/2 power flash.
- Stroboscopic flash is also possible when the camera's shooting mode is set to "**buLb**".
- When the number of flashes is displayed as "---", flashes are fired continuously until the shutter closes or the charge runs out. The maximum number of continuous flashes is shown in the table on the following page.

Maximum Number of Continuous Flashes

| Flash Output \ Hz | 1 | 2 | 3 | 4 | 5 | 6 - 7 | 8 - 9 |
|-------------------|-----|-----|-----|-----|-----|-------|-------|
| 1/4 | 7 | 6 | 5 | 4 | 4 | 3 | 3 |
| 1/8 | 14 | 14 | 12 | 10 | 8 | 6 | 5 |
| 1/16 | 30 | 30 | 30 | 20 | 20 | 20 | 10 |
| 1/32 | 60 | 60 | 60 | 50 | 50 | 40 | 30 |
| 1/64 | 90 | 90 | 90 | 80 | 80 | 70 | 60 |
| 1/128 | 100 | 100 | 100 | 100 | 100 | 90 | 80 |

| Flash Output \ Hz | 10 | 11 | 12 - 14 | 15 - 19 | 20 - 50 | 60 - 199 | 250 - 500 |
|-------------------|----|----|---------|---------|---------|----------|-----------|
| 1/4 | 2 | 2 | 2 | 2 | 2 | 2 | 2 |
| 1/8 | 4 | 4 | 4 | 4 | 4 | 4 | 4 |
| 1/16 | 8 | 8 | 8 | 8 | 8 | 8 | 8 |
| 1/32 | 20 | 20 | 20 | 18 | 16 | 12 | 10 |
| 1/64 | 50 | 40 | 40 | 35 | 30 | 20 | 15 |
| 1/128 | 70 | 70 | 60 | 50 | 40 | 40 | 30 |

- When the number of flashes is displayed as “---” (bar display), the maximum number of flashes is as shown in the tables.

1 to 199 Hz

| Flash Output | 1/4 | 1/8 | 1/16 | 1/32 | 1/64 | 1/128 |
|-------------------|-----|-----|------|------|------|-------|
| Number of Flashes | 2 | 4 | 8 | 12 | 20 | 40 |

250 to 500 Hz

| Flash Output | 1/4 | 1/8 | 1/16 | 1/32 | 1/64 | 1/128 |
|-------------------|-----|-----|------|------|------|-------|
| Number of Flashes | 2 | 4 | 8 | 10 | 15 | 30 |

Ext.A/Ext.M: Flash External Metering

The Speedlite's built-in external metering sensor measures the flash reflected from the subject in real time, and stops the flash when the standard exposure is reached.

“Auto external flash metering” can be used with the EOS digital cameras released since 2007. “Manual external flash metering” can be used with all EOS cameras.

Ext.A: Auto External Flash Metering

This enables you to perform automatic flash shooting. The flash output is automatically adjusted according to the ISO speed and aperture set in the camera.

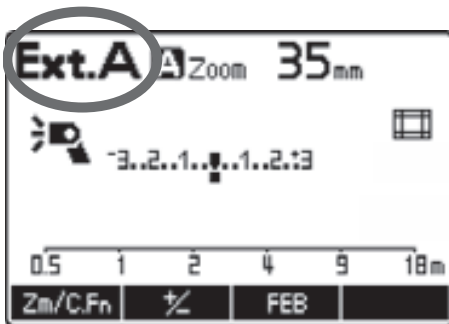
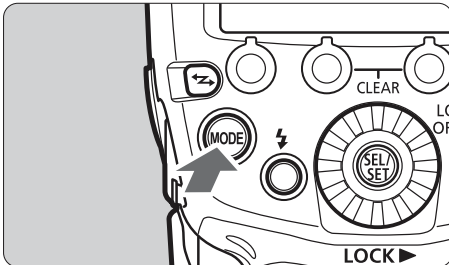

Set the flash mode to <Ext.A>.

- Press the <MODE> button and set to <Ext.A>.
- If <Ext.A> is not displayed, set the flash Custom Function to C.Fn-05-2 (p.96).
- When you press the camera's shutter button halfway, the effective flash range is displayed.



Flash exposure compensation (p.22) and FEB (p.23) are available during auto external flash metering.

Ext.M: Manual External Flash Metering

You can manually set the Speedlite with the ISO speed and aperture set in the camera. The flash output is automatically adjusted according to the ISO speed and aperture that you set.

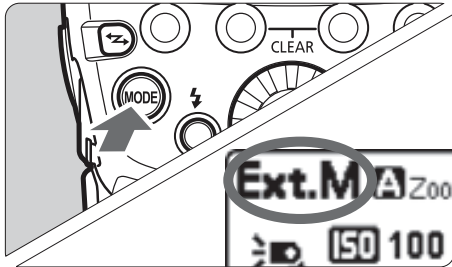

1 Set the flash mode to <Ext.M>.

- Press the <MODE> button and set to <Ext.M>.
- If <Ext.M> is not displayed, set the flash Custom Function to C.Fn-05-3 (p.96).

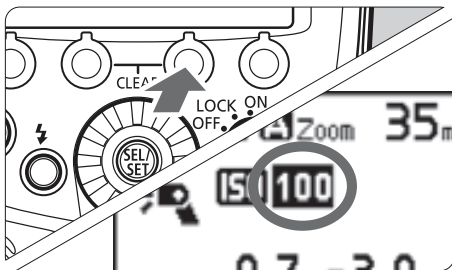

2 Set the same ISO speed as on the camera.

- Press function button 3 < ISO >.
- ▶ The ISO speed value is highlighted.
- Turn < [ISO Wheel] > to set the ISO speed, and press the < [OK] > button.
- ISO speed can be set within a maximum range of ISO 25 to 51200, in 1/3 increments.

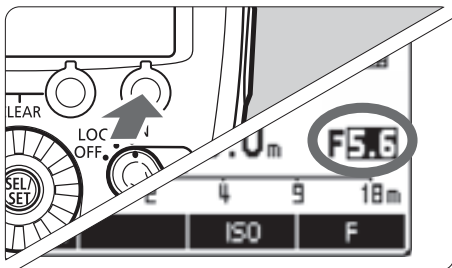

3 Set the same aperture as on the camera.

- Press function button 4 < F >.
- ▶ The aperture is highlighted.
- Turn < [Aperture Wheel] > to set the aperture, and press the < [OK] > button.



- You can check the effective flash range on the Speedlite's LCD panel.
- When using manual external flash metering and shooting with the camera and Speedlite's PC terminal connected by a commercially-available sync cord, you can shoot with the flash off the camera.
- If you connect a different Speedlite to the Speedlite's PC terminal with a sync cord, it will not fire.

Modeling Flash

When the camera's depth-of-field preview button is pressed, the flash fires continuously for 1 sec. This is called the modeling flash. It enables you to see the shadow effects on the subject, and the lighting balance during wireless flash shooting (p.47, 75).

Press the depth-of-field preview button on the camera.

▶ The flash fires continuously for 1 sec.



- To avoid degrading and damaging the flash head due to overheating, do not fire the modeling flash more than 10 times continuously. After firing it 10 times continuously, allow a rest time of at least 10 min.
- If the modeling flash is fired more than 10 times continuously, the safety function may activate and restrict flash firing. If this happens, allow a rest time of at least 15 min.
- Modeling flash is not possible when using the flash with EOS REBEL 2000/QD, EOS 300/QD or a Type-B camera.



During normal flash shooting, or when using the flash as the master unit in wireless shooting, you can fire the modeling flash with the test flash button (C.Fn-02/p.95).

Clearing Speedlite Settings

You can return the settings of the Speedlite shooting functions and wireless shooting settings to their default settings.

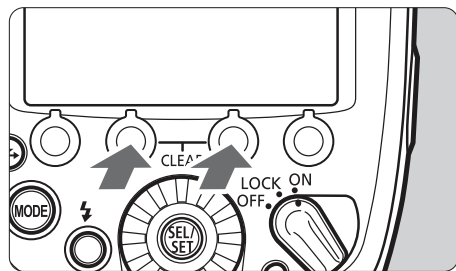

Press function buttons 2 and 3 simultaneously for 2 seconds or longer.

- ▶ The Speedlite settings are cleared and the settings return to normal shooting and <ETTL> flash mode.



Even when the settings have been cleared, the transmission channel and wireless radio ID during wireless shooting as well as the C.Fn and P.Fn settings (p.92) will not be canceled.

Color Filter

When the color temperature of the Speedlite and the color temperature of the light illuminating the subject are different, unnatural colors may result for the subject background where the flash does not reach.

By using a supplied color filter suitable for the color temperature of the illuminating light while firing the flash, you can shoot the subject and background colors with an appropriate white balance. You can also use commercially-available color filters.

Supplied Color Filters

| Filter | Density | Compensation Effect | Application |
|-------------------------|---------|---------------------|---|
| Tungsten light (orange) | Low | Low | Compensates for the effect of a tungsten light bulb |
| | High | High | |

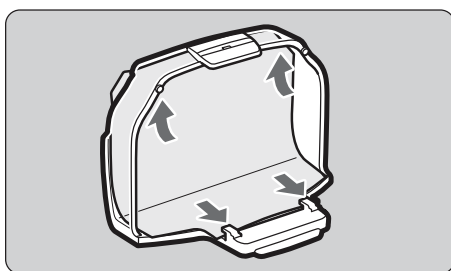

1 Attach the filter to the holder.

- Attach the supplied filter to the holder as shown in the illustration.

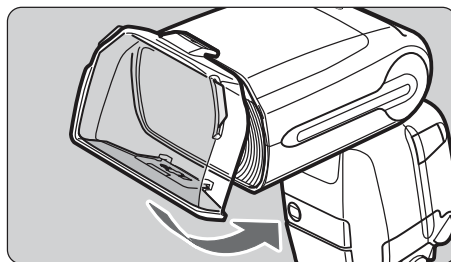

2 Attach the holder to the Speedlite.

- Attach the holder to the flash head as shown.
- The flash icon on the LCD panel changes to .
- To remove the holder, follow the procedure in reverse order. Raise the lower filter attachment pins and remove the holder from the flash head.



3 Take the picture.

- To compensate for the color temperature of the light source, set the camera's white balance to  and take the picture.

- With EOS digital cameras released since 2012, you can also set the white balance to <AWB> for shooting.
- Check the resulting image, and perform WB compensation as required.

Commercially-available Color Filters

When using a commercially-available 75 x 75 mm filter (3 in. x 3 in.), disable the automatic filter detection function (P.Fn-05-1/p.102). If you use a commercially-available color filter with P.Fn-05-0 set, <ⓘ> may be displayed. Shoot a picture with the filter attached in the actual shooting environment and set it for manual white balance. Take the picture with the white balance set to <MWB>.



- The flash guide number decreases when you use a color filter. When performing manual flash or stroboscopic flash with one of the supplied color filters, set flash exposure compensation according to the following guidelines.
 [Low] Orange: +1/3 stop, [High] Orange: +1 stop
- When P.Fn-05-0 is set, if you use a commercially-available color filter whose color is close to the supplied color filters, <ⓘ> may not be displayed.
- As shown in step 1 on the preceding page, attach the filter all the way to the position of the filter attachment pins on the holder. If the filter is not attached correctly, it may not be detected.
- When using a filter, the use of full power or continuous flashes is not recommended. The filter may deform due to the heat of the flash.
- The denser the color of the filter, the more likely it is to deform due to the heat of the flash.



- With cameras that are not compatible with color temperature information transmission (p.20), set the white balance to <MWB> and shoot in the same way as described in “Commercially-available Color Filters”.
- When using a commercially-available coloring filter, you do not need to set the white balance to <MWB>.
- Attaching the holder does not affect the flash coverage.
- Even if the filter deforms due to the heat of the flash, it does not affect its compensation effect.
- Filters are consumable parts. When the supplied filters have worn out or degraded, purchase new genuine filters.
- If dirt or dust adheres to a filter, wipe it off with a soft, dry cloth.
- If the color filter sensor (p.6) or the holder reflection area (p.11) is dirty or dusty, clean it with a blower or similar tool.

3

Setting Flash Functions with Camera Operations

This chapter describes how to set the flash functions from the camera's menu screen.

 When the camera's shooting mode is set to a fully automatic mode or an Image Zone mode, the operations in this chapter are not available. Set the camera's shooting mode to **P/Tv/Av/M/B** (Creative Zone mode).

Flash Control from Camera's Menu Screen

When using EOS digital cameras released since 2007, you can set flash functions or Custom Functions from the camera's menu screen. For the camera operations, see the camera's instruction manual.

Flash Function Setting

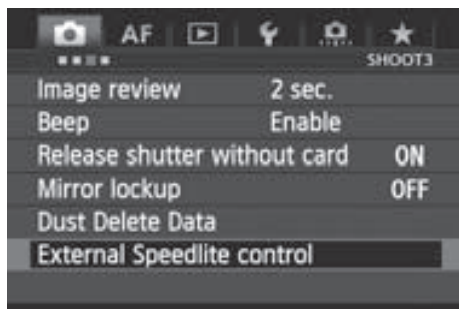

1 Select [External Speedlite control].

- Select [External Speedlite control] or [Flash control].

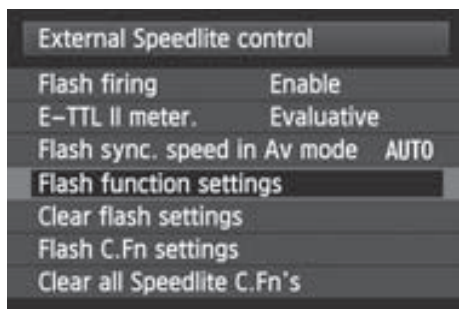

2 Select [Flash function settings].

- Select [Flash function settings] or [External flash func. setting].
- ▶ The screen changes to the (external) flash function settings screen.

3 Set the function.

- The setting screen varies depending on the camera.
- Select an item and set the function.

Example of EOS-1D X screen

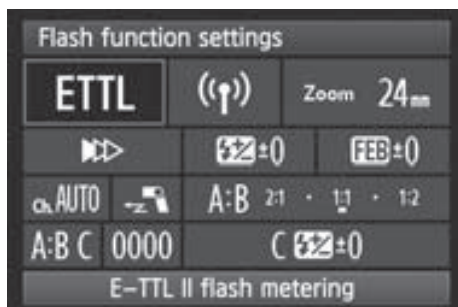

Example of EOS 60D screen

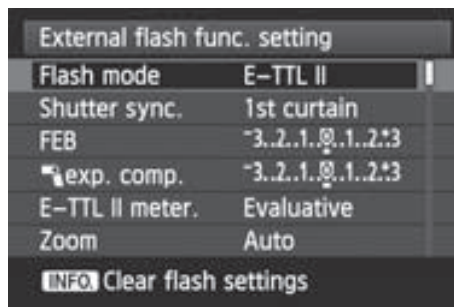

The cameras released from 2007 to 2011 are as follows.

EOS-1Ds Mark III, EOS-1D Mark IV/III, EOS 5D Mark II, EOS 7D/60D/50D/40D, EOS REBEL T3i/600D, EOS REBEL T2i/550D, EOS REBEL T1i/500D, EOS REBEL XSi/450D, EOS REBEL T3/1100D, EOS REBEL XS/1000D

Settings Available in [Flash function settings]

- **EOS digital cameras released since 2012**

When using the flash with cameras such as EOS-1D X, you can set the functions for “Normal shooting”, “Radio transmission wireless shooting” or “Optical transmission wireless shooting” in the **[Flash function settings]** screen.

- **EOS digital cameras released from 2007 to 2011**

You can set the functions for “Normal shooting” or “Optical transmission wireless shooting” in the **[Flash function setting]** screen. To use “Radio transmission wireless shooting”, set the functions by operating the flash.

The settable functions are as follows. The available settings vary depending on the flash mode or wireless function setting.

| Function | | Reference Page | |
|---|---|----------------|------|
| Flash firing | Enable / Disable | p.44 | |
| E-TTL II flash metering | Evaluative / Average | | |
| Flash synchronization speed in Av mode | | | |
| Flash mode | E-TTL II (autoflash) / Manual flash / MULTI flash / Auto external flash metering / Manual external flash metering / TTL (autoflash) | | |
| Shutter synchronization | 1st curtain / 2nd curtain / Hi-speed | | |
| Flash exposure compensation | | | |
| FEB | | | |
| Zoom (flash coverage) | | | |
| Wireless functions (setting) | Radio transmission wireless / Optical transmission wireless | | p.45 |
| Clear Speedlite function settings | | | |



- **[Flash firing]** and **[E-TTL II flash metering]** are displayed in step 2 or step 3 on the preceding page (depending on the camera).
- When **[Flash sync. speed in Av mode]** is not displayed, it can be set with the camera's Custom Function.

- **Flash firing**
To perform flash shooting, set to [**Enable**]. To use the flash's AF-assist beam only, set to [**Disable**].
- **E-TTL II flash metering**
For normal exposures, set it to [**Evaluative**].
If [**Average**] is set, the flash exposure will be averaged for the entire scene metered by the camera. Flash exposure compensation may be necessary depending on the scene. This setting is for advanced users.
- **Flash synchronization speed in Av mode**
You can set the flash sync speed when shooting in aperture-priority AE (**Av**) mode with flash.
- **Flash mode**
You can select the flash mode from [**E-TTL II**], [**Manual flash**], [**MULTI flash**], [**AutoExtFlash**] and [**Man.ExtFlash**] to suit your desired flash shooting.
When the flash's Custom Function C.Fn-05 is set to [**1:TTL**] (p.96), [**TTL**] can be selected. When performing autoflash shooting with an EOS digital camera, set to [**0:E-TTL II/E-TTL**].
- **Shutter synchronization**
You can select the flash firing timing/method from [**1st curtain**], [**2nd curtain**] and [**High-speed synchronization**]. To perform normal flash shooting, set [**1st curtain**].
- **Flash exposure compensation**
In the same way as normal exposure compensation, you can set exposure compensation for flash. The flash exposure compensation amount can be set up to ± 3 stops in 1/3-stop increments.
- **FEB**
You can take three shots while automatically changing the flash output. The settable range is up to ± 3 stops in 1/3-stop increments.

- **Zoom (flash coverage)**

You can set the flash coverage for the Speedlite. When [**Auto**] is selected, the flash coverage is set automatically according to the focal length of the lens.

- **Wireless flash functions (setting)**

You can perform wireless flash shooting. Two wireless flash shooting methods are available; radio transmission and optical transmission. For details, see Chapter 4 and Chapter 5.

- **Clear Speedlite (function) settings**

You can return the flash settings to their default settings.



When flash exposure compensation is set on the flash, you cannot set flash exposure compensation in the camera's menu screen. Note that if both are set at the same time, the setting on the flash is given priority.

Flash Custom Function Settings

The displayed contents vary depending on the camera. When C.Fn-20 to 23 are not displayed, set them by operating the flash unit. For the Custom Functions, see pages 95 to 100.

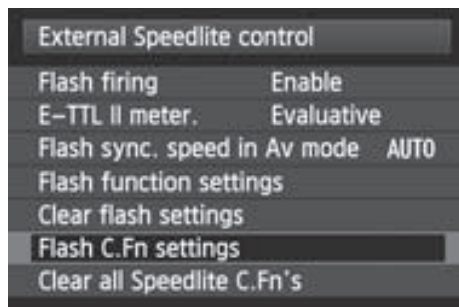

1

Select [Flash C.Fn settings].

- Select [**Flash C.Fn settings**] or [**External flash C.Fn setting**].
- ▶ The screen changes to the (external) flash Custom Function settings screen.

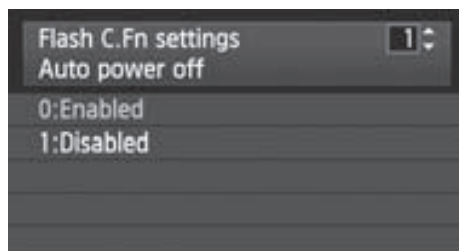

2

Set the Custom Function.

- Select the Custom Function number and set the function.
- To clear all the Custom Function settings, select [**Clear all Speedlite C.Fn's**] or [**Clear ext. flash C.Fn set.**] in step 1.



- When using a camera released up to 2011, the C.Fn-20 to 23 settings are not cleared even if [**Clear all Speedlite C.Fn's**] is selected. When following the “Clearing All the Custom Functions” operation on page 94, all the Custom Functions (except C.Fn-00) are cleared.
- When using the flash with EOS digital cameras released since 2012, as auto external metering and manual external metering can be automatically selected with the flash's <MODE> button, C.Fn-05-2, 3 are not displayed.



You cannot set or clear all Personal Functions (P.Fn/p.101) from the camera's menu screen. Set them by operating the flash unit.

4

Wireless Flash Shooting: Radio Transmission

This chapter describes wireless flash shooting using radio transmission.

For the accessories required for radio transmission wireless shooting, see the system map (p.104). For the regions of use, restrictions, and precautions related to radio transmission, refer to the separate leaflet.



- When using a Speedlite 600EX (without radio transmission function), the shooting in this chapter is not available. To shoot with optical transmission wireless flash, see Chapter 5 (p.75).
- When the camera's shooting mode is set to a fully automatic mode or an Image Zone mode, the operations in this chapter are not available. Set the camera's shooting mode to P/Tv/Av/M/B (Creative Zone mode).



- The 600EX-RT attached to the camera is called the master unit, and a 600EX-RT that is wirelessly controlled is called the slave unit.
- You can also wirelessly control the 600EX-RT set as the slave unit with the Speedlite Transmitter ST-E3-RT (sold separately). For details on setting the master unit functions, see the transmitter's instructions.

(📡) Radio Transmission Wireless Flash Shooting

Using a Canon Speedlite (master/slave) with a radio transmission wireless shooting function makes it easy to shoot with advanced wireless multiple flash lighting, in the same way as normal E-TTL II/E-TTL autoflash shooting.

The system is designed so that the settings of the 600EX-RT attached to the camera (master) are automatically reflected on the 600EX-RT that is wirelessly controlled (slave). Therefore, you do not need to operate the slave unit while shooting.

The basic relative positions and operating range are as shown in the figure. You can then perform wireless E-TTL II/E-TTL autoflash shooting just by setting the master unit to **<ETTL>**.

Positioning and Operation Range (Example of wireless flash shooting)

● Autoflash Shooting Using One Slave Unit (p.57)

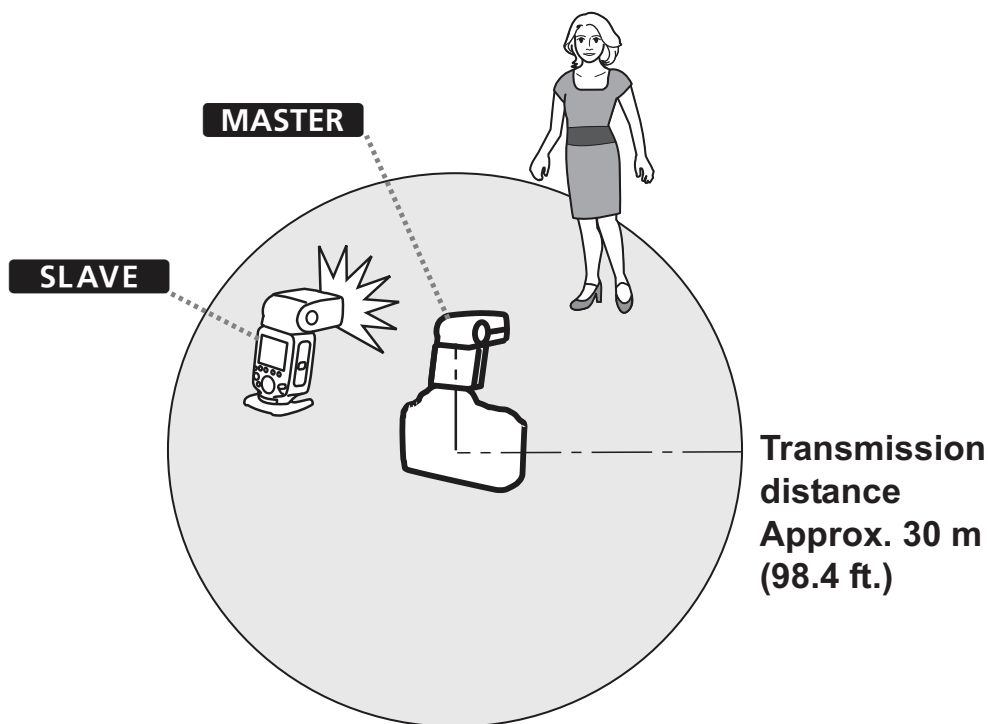

- Position the slave unit using the supplied mini stand (p.11).
- Before shooting, perform a test flash (p.16) and test shooting.
- The transmission distance may be shorter depending on the conditions such as the positioning of slave units, the surrounding environment and weather conditions.

Wireless Multiple Flash Shooting

You can divide the slave units into two or three groups and perform E-TTL II/E-TTL autoflash shooting while changing the flash ratio (factor). In addition, you can set and shoot with a different flash mode for each firing group, for up to 5 groups.

- **Autoflash Shooting with Two Slave Groups** (p.61)

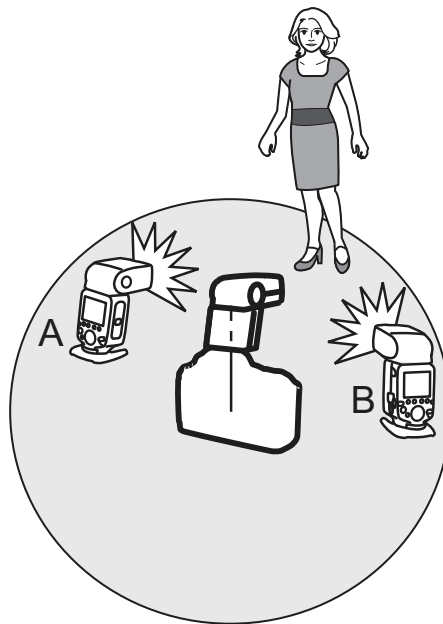

- **Autoflash Shooting with Three Slave Groups** (p.62)

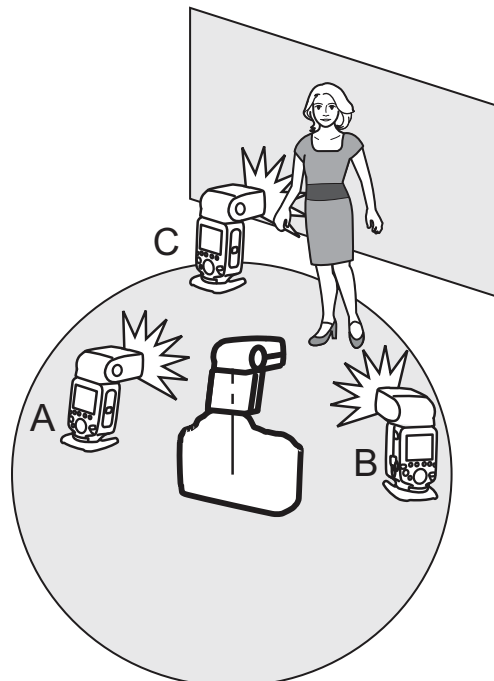

● Shooting with a Different Flash Mode set for Each Group (p.65)

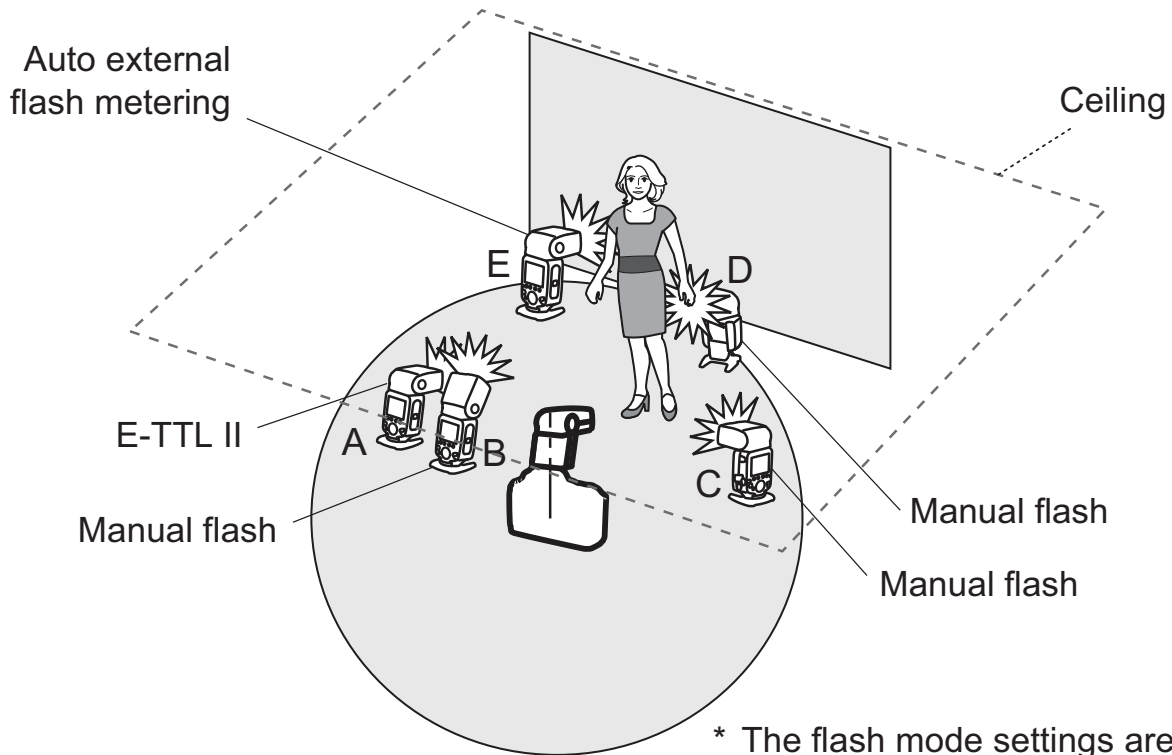

* The flash mode settings are indicated only as an example.

Difference between Radio Transmission and Optical Transmission

Wireless shooting using radio transmission has advantages over wireless shooting using optical transmission, such as being less affected by obstacles, and not having to point the slave unit's wireless sensor toward the master unit. The main functional differences are as follows.

| Function | | Radio Transmission | Optical Transmission |
|----------------------------|-------------------|--|-----------------------------------|
| Transmission distance | | Approx. 30 m (98.4 ft.) | Approx. 15 m (49.2 ft.) (indoors) |
| Firing group control | | Up to 5 groups* ¹ (A/B/C/D/E) | Up to 3 groups (A/B/C) |
| Slave unit control | | Up to 15 units | No restriction |
| Channel | | Auto, Ch. 1 - 15 | Ch. 1 - 4 |
| Wireless radio ID | | 0000 - 9999 | — |
| Operations from slave unit | Test flash firing | ○ | — |
| | Modeling flash | ○* ² | — |
| | Release | ○* ³ | — |

*1, *2 and *3: Some restrictions apply depending on the camera that you use. (Refer to *1: p.51, 65; *2: p.67; and *3: p.68.)

About Restrictions on Functions Depending on the Camera Used

When performing radio transmission wireless flash shooting, restrictions may apply to the flash mode, maximum flash sync speed (referred to below as the “flash sync speed”) and high-speed sync function, depending on the camera that you use.

- **EOS digital cameras released since 2012**

When using the flash with a camera such as the EOS-1D X, you can shoot without any restrictions on the flash mode and flash sync speed.

- **EOS cameras compatible with E-TTL and released up to 2011**

When using the flash with the cameras listed below, radio transmission wireless shooting using E-TTL autofocus is not possible. Shoot with manual flash (p.31), stroboscopic flash (p.33) or optical wireless transmission (p.75).

EOS-1Ds, EOS-1D, EOS-1V, EOS-3, EOS ELAN II(E)/
EOS 50(E), EOS REBEL 2000/EOS 300, EOS REBEL G/
EOS 500N, EOS 66/EOS Rebel XS N/EOS 3000 N, EOS IX(E),
EOS IX Lite/EOS IX 7

Also, when using the flash with a film or digital camera released up to 2011, the following restrictions apply.

1. **The flash sync speed is 1 increment slower**

Check the flash sync speed ($X = 1/**$ sec.) of your camera, and shoot with a shutter speed up to a maximum of 1 stop slower than the flash sync speed (Example: When $X = 1/250$ sec., radio transmission wireless shooting is possible from $1/125$ sec. to 30 sec.). Also, **high-speed sync shooting is not possible.** When you set the shutter speed 1 increment slower than the flash sync speed, the <⚠Tv> warning icon will disappear.

2. **Group flash is not possible** (p.65).

Wireless Settings

To perform radio transmission wireless shooting, set the master unit and slave unit with the following procedure.

Master Unit Setting

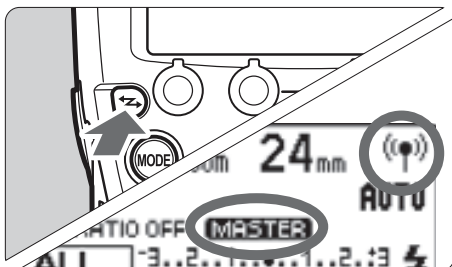

Display <((Ⓜ))> and < **MASTER** >.

- Press the <⏏> button to display <((Ⓜ))> (radio transmission) and < **MASTER** >.

Slave Unit Setting

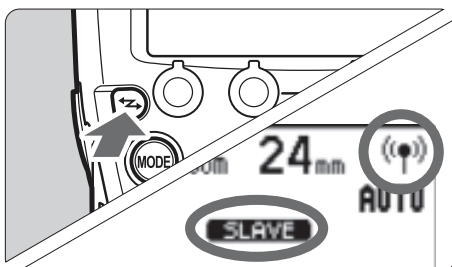

Display <((Ⓜ))> and < **SLAVE** >.

- Operate and set the flash you want to set as the slave unit.
- Press the <⏏> button to display <((Ⓜ))> (radio transmission) and < **SLAVE** >.



To perform normal flash shooting, press the <⏏> button to clear the wireless (master/slave) settings.

Transmission Channel/Wireless Radio ID Settings

To avoid interference with wireless multiple flash systems using radio transmission that are used by other photographers, or with other devices that use radio waves (wireless), you can change the transmission channel and wireless radio ID. **Set the same channel and ID for both the master unit and slave unit.**



When establishing multiple radio transmission wireless flash systems, interference between flash systems may occur, even if the flashes are set to different channels. Set different radio transmission IDs for each channel (p.53).

● Setting the Transmission Channel/Wireless Radio ID of the Master Unit and Slave Unit

Use the following procedure to set the transmission channels and wireless radio IDs of the master unit and slave unit. Set the same channel and ID for both the master unit and slave unit. The procedure is the same for the master unit and slave unit.

1 Set the < MENU 3 > display.

- Press function button 4 to display < MENU 3 >.

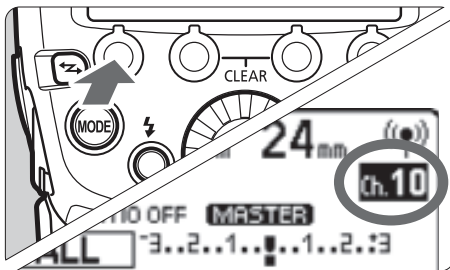

2 Set a channel.

- Press function button 1 < CH >.
- Turn < [rotary] > to select "AUTO" or a channel from Ch. 1 to 15, and press the < [rotary] > button.

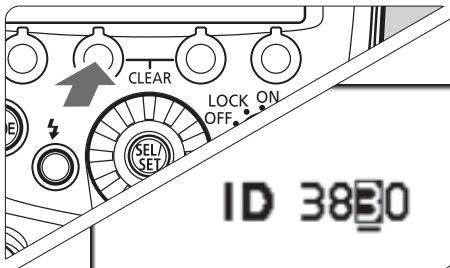

3 Set a wireless radio ID.

- Press function button 2 < ID >.
 - Turn < [rotary] > to select the position (digit) to set, and press the < [rotary] > button.
 - Turn < [rotary] > to select a number from 0 to 9, and press the < [rotary] > button.
 - Repeat step 3 to set a 4-digit number.
 - Press function button 4 < [return] > to return to the shooting-ready state.
- ▶ When transmission between the master unit and slave unit is established, the < LINK > lamp is lit in green.

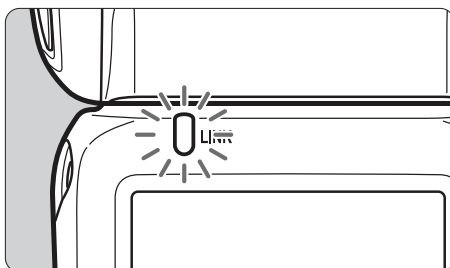

● Scanning the Master Unit Transmission Channels to Set

You can scan the radio reception status and set the master unit's transmission channel automatically or manually. When the channel is set to "AUTO", the channel with the best reception signal is automatically set. When setting the channel manually, you can set the transmission channel again while referring to the scan results.

Scanning while "AUTO" is set

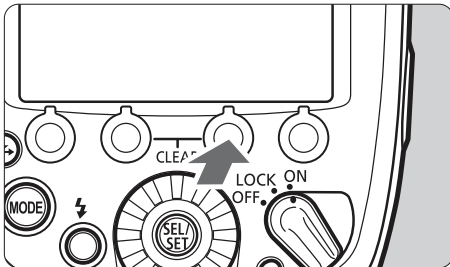

Run the scan.

- Press function button 4 to display < MENU 3 >.
- Press function button 3 < SCAN >.
- ▶ The channel is reset to one with a good reception signal.

Scanning while Ch. 1 to 15 is set

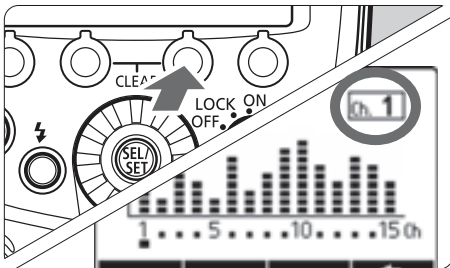

1 Run the scan.

- Press function button 4 to display < MENU 3 >.
- Press function button 3 < SCAN >.
- ▶ The radio reception status is displayed in a graph.
- The higher the peak of the channel in the graph, the better the radio reception signal.

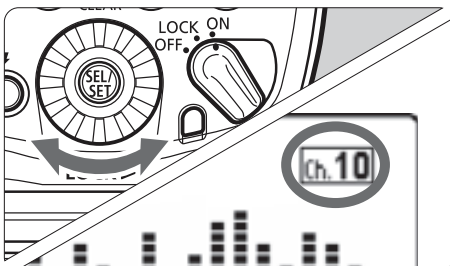

2 Set a channel.

- Turn < ⌚ > to select a channel from Ch. 1 to 15.
- Press the < ⌚ > button to set the channel and return to the shooting-ready state.

About the <LINK> Lamp

The color of the <LINK> lamp changes depending on the transmission status of the master unit and the slave unit.

| Color | Status | Description | Action |
|-------|----------|-----------------|---|
| Green | Lit | Transmission OK | – |
| Red | Lit | Not connected | Check the channel and ID |
| | Blinking | Too many units | Master units + slave units = 16 units or less |
| | | Error | Turn the power off and on again |



- If the transmission channels of the master unit and slave unit are different, the slave unit does not fire. Set both to the same number, or set both to “AUTO”.
- If the wireless radio IDs of the master unit and slave unit are different, the slave unit does not fire.

Master Flash Firing ON/OFF

You can set whether or not to fire, as a wireless flash, the master unit that controls the slave unit. When master flash firing is set to ON, the master unit is fired as firing group A.

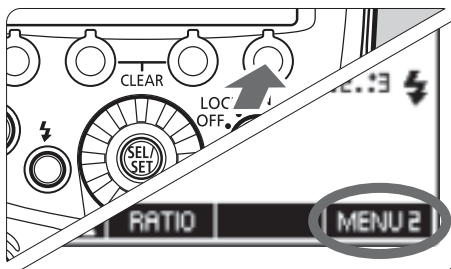

1 Set the < MENU 2 > display.

- Press function button 4 to display < MENU 2 >.

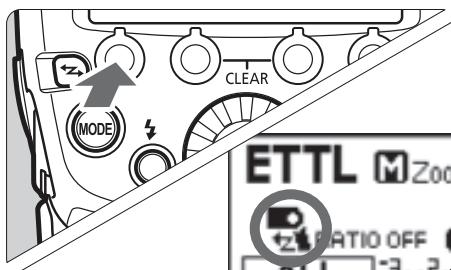

2 Set the master flash firing.

- Press function button 1 < R/R > to set the master flash firing to ON or OFF.

 : Master flash firing ON

 : Master flash firing OFF

About the Memory Function

You can save the wireless settings in the master unit and slave unit, and recall the settings later. Operate the master unit or slave unit separately depending on which unit's settings are to be saved or recalled.

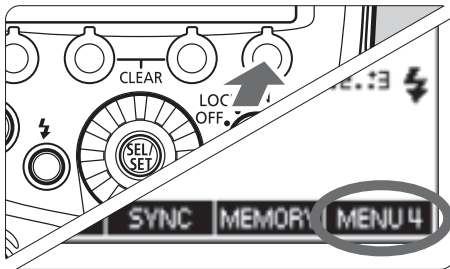

1 Press function button 4.

- On the master unit, press function button 4 to display < **MENU 4** >.
- On the slave unit, press function button 4 to display < **MENU 3** >.



2 Save or load the settings.

- Press function button 3 < **MEMORY** >.

[Save]

- Press function button 1 < **SAVE** >.
- ▶ The settings are saved (stored in the memory).

[Load]

- Press function button 2 < **LOAD** >.
- ▶ The settings that were saved are set.

ETTL: Fully Automatic Wireless Flash Shooting

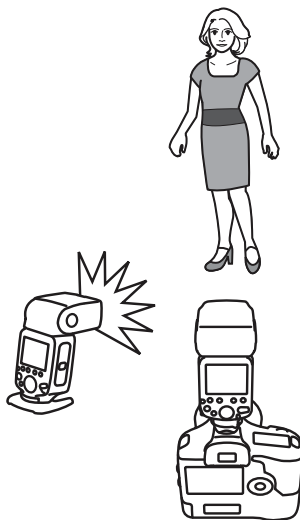

This section describes basic fully automatic wireless shooting when using a 600EX-RT attached to the camera (master) and a 600EX-RT wirelessly controlled (slave).

Autoflash Shooting Using One Slave Unit

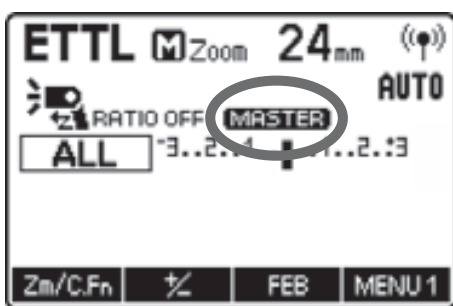

1 Set the master unit.

- Set the 600EX-RT attached to the camera as the master unit (p.52).
- You can also use a Speedlite Transmitter ST-E3-RT (sold separately) as the master unit.

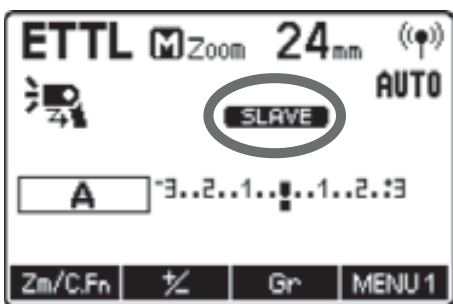

2 Set the slave unit.

- Set the 600EX-RT to be controlled wirelessly as the slave unit (p.52).
- Set A, B or C as the firing group. The flash will not fire if it is set to D or E.

3 Check the channel and ID.

- If the channels and IDs of the master unit and slave unit are different, set them to the same numbers (p.53, 54).

4 Position the camera and the flash.

- Position them within the range shown on page 48.

5 Set the flash mode to <ETTL>.

- Press the <MODE> button on the master unit and set the flash mode to <ETTL>.
- The slave unit is set automatically to <ETTL> during shooting via the control from the master unit.
- To also fire the master unit, set the master flash firing to ON (p.55).

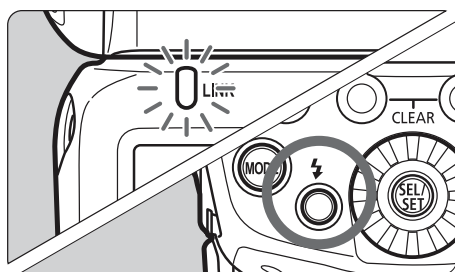

6 Check the transmission status and that the flash is ready.

- Check that the <LINK> lamp is lit in green.
- When the slave flash is ready, the AF-assist beam emitter blinks at 1-second intervals.
- Check that the <⚡> slave flash-ready icon is lit on the master unit's LCD panel.
- When the recycling of all the flash units is completed, the master unit's flash-ready lamp lights.

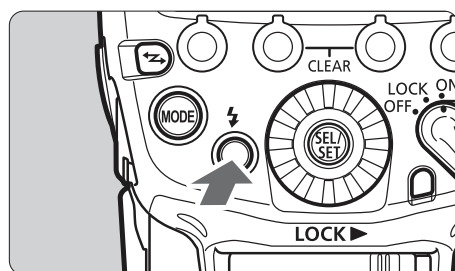

7 Check the operation.

- Press the master unit's test flash button.
- ▶ The slave unit flashes. If the slave unit does not fire, check that it is placed within the operation range.

8 Take the picture.

- Set the camera and take the picture, in the same way as with normal flash shooting.
- ▶ If a standard flash exposure was obtained, the flash exposure confirmation lamp lights for 3 sec.

❗ If the <LINK> lamp is red, radio transmission has not been established. Check again the transmission channels and wireless radio IDs of the master unit and slave unit. If you cannot connect with the same settings, turn the power off and on again.

Autoflash Shooting Using Multiple Slave Units

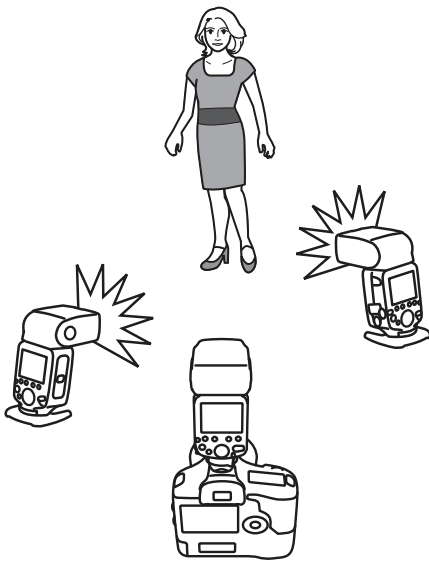

When you need more flash output or you want to perform lighting more easily, you can increase the number of slave units and fire them as a single flash.

To add slave units, use the same procedure as “Autoflash Shooting Using One Slave Unit”. Set A, B or C as the firing group. The flash will not fire if it is set to D or E.



When the number of slave units is increased or master flash firing set to ON, automatic control is performed to fire all flashes at the same flash output and ensure that the total flash output results in the standard exposure.





- The master/slave flash coverage is set automatically to 24 mm. You can also set the flash coverage manually.
- You can press the depth-of-field preview button on the camera to fire the modeling flash (p.38).
- When the Speedlite is set as the master unit, the time until auto power off takes effect is 5 min.
- If the slave unit's auto power off takes effect, press the master unit's test flash button (p.16) to turn on the slave unit. Note that the test flash cannot be fired while the camera's metering timer is operating.
- The autoflash system (E-TTL II/E-TTL) depends on the camera used and is set automatically. Note that <ETTL> is displayed on the LCD panel for both systems.
- You can change the time until the slave unit's auto power off takes effect (C.Fn-10/p.98).
- You can enable a beep to sound when the charge of all the slave units is complete (C.Fn-20/p.99).
- You can set it up so that the AF-assistant beam emitter will not blink when the slave unit recycling is completed (C.Fn-23/p.100).

Using Fully Automatic Wireless Flash

Flash exposure compensation and other settings set on the master unit will also be automatically set in the slave unit(s). You do not need to operate the slave unit. Wireless flash shooting with the following settings can be performed in the same way as in normal flash shooting.

- **Flash exposure compensation** ( /p.22)
- **FEB** ( /p.23)
- **FE lock** (p.24)
- **High-speed sync** ( /p.25)
- **Manual flash** (p.31, 64)
- **Stroboscopic flash** (p.33)



<  >, <  > and <  > are displayed when function button 4 is pressed.

About Master Units

You can use two or more master units (master units + slave units = maximum of 16 units). By preparing multiple cameras with master units attached, you can shoot by changing cameras while keeping the same lighting (slave units).

Note that when using two or more master units, the color of the <LINK> lamp varies depending on the order in which the power was turned on. The first master (main master) is green and the second and subsequent masters (sub-masters) are orange.



If the <LINK> lamp is red, the connection has not been established. After checking the transmission channel and wireless radio ID, turn the power of each master unit off, and turn it on.

ETTL: Wireless Multiple Flash Shooting with Flash Ratio

Autoflash Shooting with Two Slave Groups

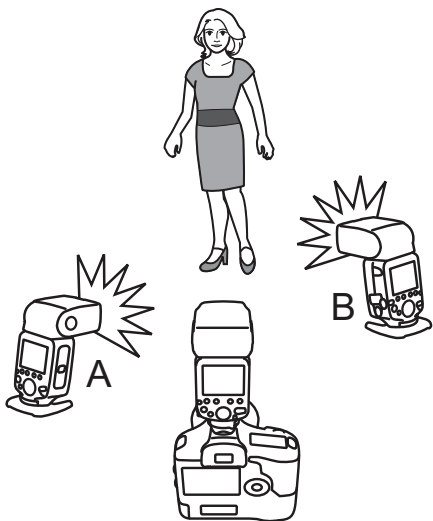

You can divide the slave units into two firing groups, A and B, and adjust the lighting balance (flash ratio) for shooting. The exposure is controlled automatically so that the total flash output of firing groups A and B results in the standard exposure.

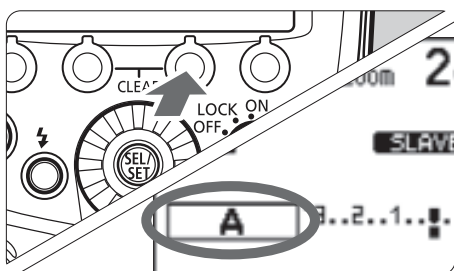

1 Set the firing group of the slave units.

- Operate and set the slave units one by one.
- While **<MENU 1>** is displayed, press function button 3 **<Gr>** and select **<A>** or ****.
- Set one unit to **<A>** and set the other to ****.

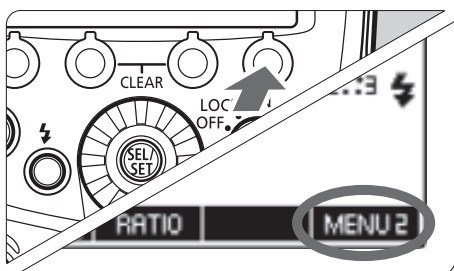

2 Display **<MENU 2>**.

- The operations in steps 2 to 4 are set on the master unit.
- Press function button 4 on the master unit to display **<MENU 2>**.

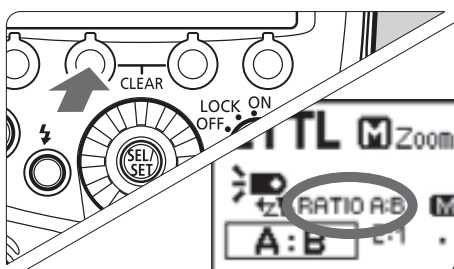

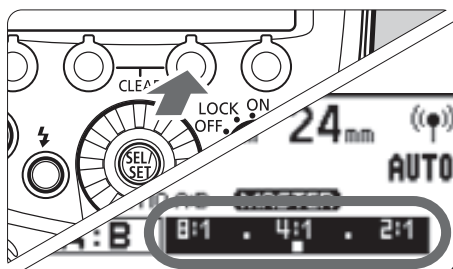

3 Set to **<RATIO A:B>**.

- Press function button 2 **<RATIO>** and set to **<RATIO A:B>**.



4 Set the flash ratio.

- Press function button 3 < **Gr** >.
- Press function button 3 < **A:B** >.
- Turn <  > to set the flash ratio, and press the <  > button.
- Press function button 4 < **↶** > to return to the shooting-ready state.

5 Take the picture.

- ▶ The slave unit flashes at the set flash ratio.

Autoflash Shooting with Three Slave Groups

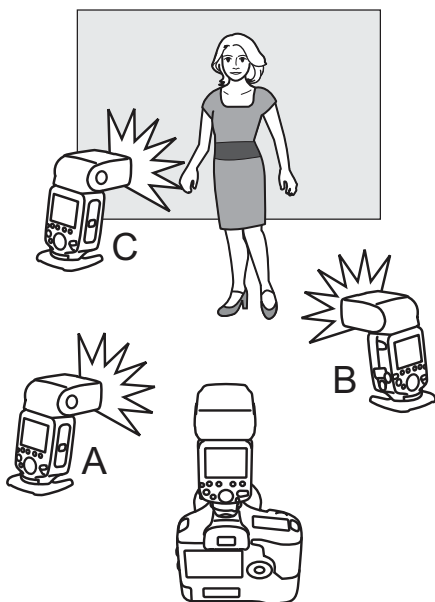

You can add firing group C to firing groups A and B. C is convenient to set lighting so as to eliminate the subject's shadow.

The basic setting method is the same as "Autoflash Shooting with Two Slave Groups".





1 Set firing group C.

- Set the slave unit you want to add to flash firing group < **C** > in the same way as step 1 on the preceding page.

2 Set to <RATIO A:B C>.

- Set the master unit to < **RATIO A:B C** > in the same way as steps 2 and 3 on the preceding page.

3 Set flash exposure compensation as required.

- Press function button 3 < **Gr** >, turn <  > and select < **C** >.
- Press function button 3 < **c ±** >.
- Turn <  > to set the flash exposure compensation amount, and press the <  > button.
- Press function button 4 <  > to return to the shooting-ready state.

Slave Group Control

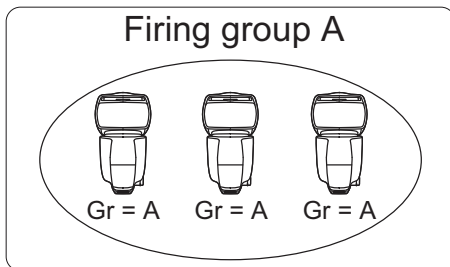

If you need more flash output or wish to perform more sophisticated lighting, you can increase the number of slave units. Simply set an additional slave unit to the firing group (A, B or C) whose flash output you want to increase. You can increase the number of slave units up to 15 units in total.

For example, if you set a firing group with three slave units to < **A** >, the three units are treated and controlled as a single firing group A with a large flash output.



- To fire the three firing groups A, B and C at the same time, set < **RATIO A:B C** >. With the < **RATIO A:B** > setting, firing group C does not fire.
- If you shoot with firing group C pointing directly toward the main subject, overexposure may result.



- The flash ratio of 8:1 to 1:1 to 1:8 is equivalent to 3:1 to 1:1 to 1:3 (1/2-stop increments) when converted to number of stops.
- The details of the flash ratio settings are as follows.



M: Wireless Multiple Flash Shooting with Manual Flash Output

This describes wireless (multiple flash) shooting using manual flash. You can shoot with a different flash output setting for each slave unit (firing group). Set all parameters on the master unit.

1 Set the flash mode to <M>.

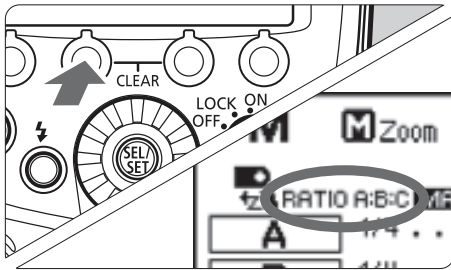

2 Set the number of firing groups.

- While <MENU 1> is displayed, press function button 2 <RATIO> and set the groups to fire.
- The setting changes as follows each time you press the button:
ALL (<RATIO OFF>) →
A/B (<RATIO A:B>) →
A/B/C (<RATIO A:B:C>).

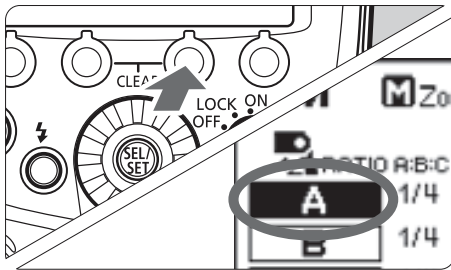

3 Select a firing group.

- Press function button 3 <Gr>, turn <⊙> and select the group for which you want to set the flash output.

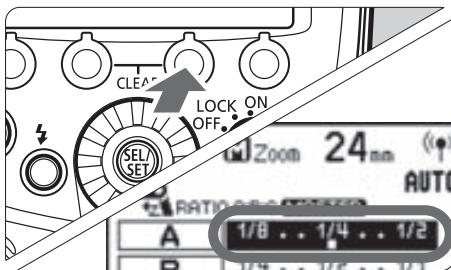

4 Set the flash output.

- Press function button 3 <*/>.
- Turn <⊙> to set the flash output, and press the <⊙> button.
- Repeat steps 3 and 4 to set the flash output of all groups.

5 Take the picture.

- ▶ Each group fires at the set flash ratio.



- When ALL <RATIO OFF> is set, set A, B or C as the firing group for the slave units. The flash will not fire if it is set to D or E.
- To fire multiple slave units with the same flash output, select ALL <RATIO OFF> in step 2.

Gr: Shooting with a Different Flash Mode for Each Group

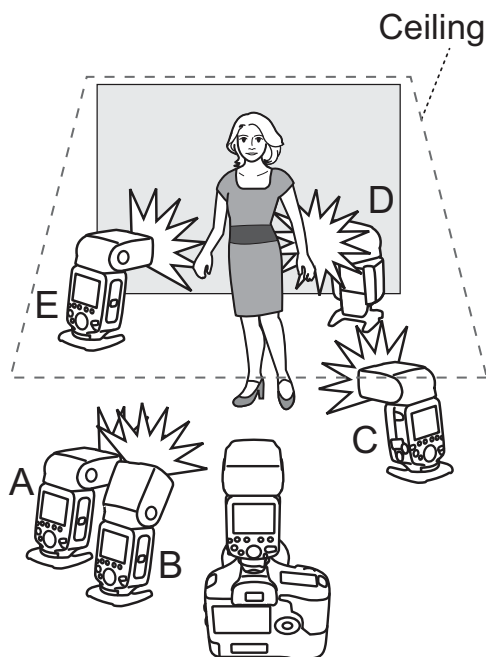

When using an EOS digital camera released since 2012, such as the EOS-1D X, you can shoot with a different flash mode set for each firing group, with up to 5 groups (A/B/C/D/E).

The flash modes that can be set are ① E-TTL II/E-TTL autoflash, ② Manual flash and ③ Auto external flash metering. When the flash mode is ① or ③, exposure is controlled to result in standard exposure for the main subject as a single group.

This function is for advanced users who are very knowledgeable and experienced in lighting.

❗ Wireless flash shooting using the <Gr> flash mode cannot be performed with cameras released up to 2011. Shooting with up to 3 groups (A/B/C) is set (p.62).

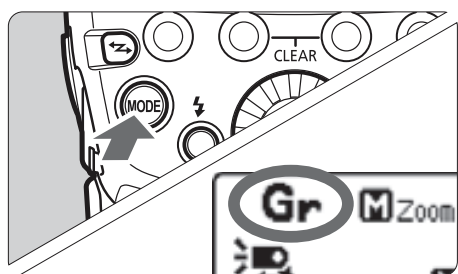

1 Set the flash mode to <Gr>.

- Press the <MODE> button on the master unit and set the flash mode to <Gr>.

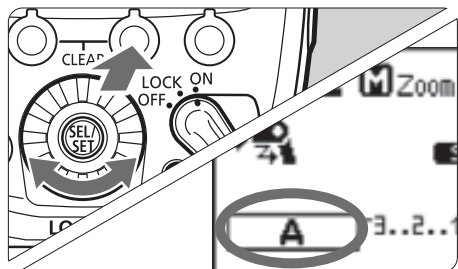

2 Set the firing group of the slave units.

- Operate and set the slave units one by one.
- While <MENU 1> is displayed, press function button 3 <Gr> and select <A>, , <C>, <D> or <E>.
- Set the firing group (A/B/C/D/E) for all the slave units.

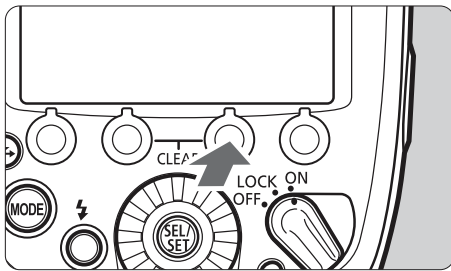

3 Set the flash mode.

- Set the flash mode of each firing group by operating the master unit.
- While **<MENU 1>** is displayed, press function button 3 **<Gr>** and turn **<SEL/SET>** to select the group.
- Press function button 2 **<*MODE>** and select the flash mode of the selected group from **<ETTL>**, **<M>** and **<Ext.A>**.
- To turn the firing of the selected group off, press function button 1 **<ON/OFF>** to set it to **<OFF>**.
- Repeat step 3 to set the flash mode of all groups.

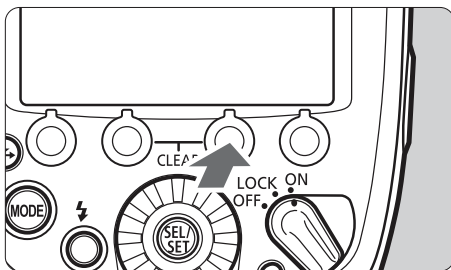
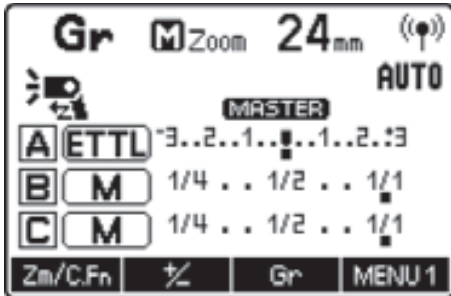

4 Set the flash output or flash exposure compensation amount.

- While a firing group is selected, press function button 3 **<*1/2>**.
- Turn **<SEL/SET>** to set the flash function corresponding to the flash mode, and press **<SEL/SET>**.
- When using the **<M>** mode, set the flash output. When using the **<ETTL>** or **<Ext.A>** mode, set the flash exposure compensation amount as required.
- If you press function button 2 **<1/2>** when **<MENU 1>** is displayed, flash exposure compensation can be set for all the firing groups.
- Repeat step 4 to set the flash function of all groups.
- Press function button 4 **<Return>** to return to the shooting-ready state.

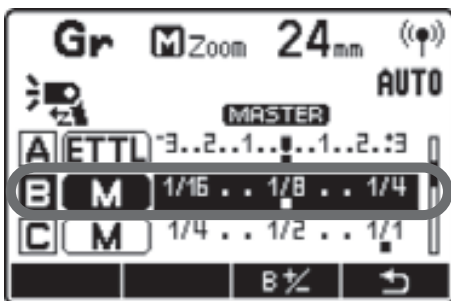

5 Take the picture.

- ▶ Each slave unit fires in the respective flash modes set.

! When the flash mode of the firing group is set to **<ETTL>** or **<Ext.A>**, exposure is controlled to obtain a standard exposure for the main subject as a single group. If you shoot with multiple firing groups pointing toward the main subject, overexposure may result.

! The firing groups to be fired do not need to be consecutive; for example, A, C, E can be set.

Test Flash and Modeling Flash from a Slave Unit

In radio transmission wireless shooting, you can fire the test flash and modeling flash from a 600EX-RT set as a slave unit.

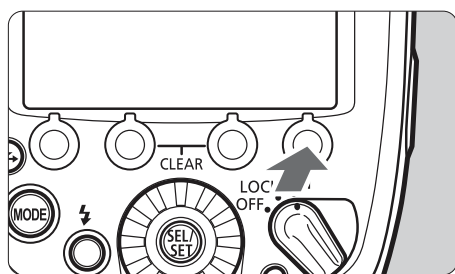

1 Display **<MENU 2>**.

- Press the slave unit's function button 4 to display **<MENU 2>**.
- ▶ **<MODEL>** and **<TEST>** are displayed.

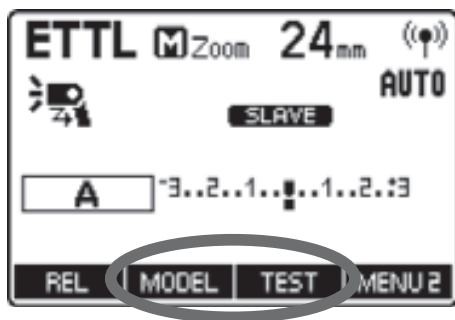

2 Fire the flash.

Test flash

- Press the slave unit's function button 3 **<TEST>**.

Modeling flash (p.38)

- Press the slave unit's function button 2 **<MODEL>**.

!

- Modeling flash is not possible from a slave unit with cameras released up to 2011.
- For the precautions related to modeling flash, see page 38.

! When two or more units are set to master, the master unit with the **<LINK>** lamp lit in green is the one that fires.

Remote Release from a Slave Unit

In radio transmission wireless shooting, you can perform remote release (remote control shooting) from a 600EX-RT set as a slave unit. When shooting with this function, the “Release Cable SR-N3” (sold separately) may be needed, depending on your camera.

Cameras Compatible with Slave Unit Remote Release

For EOS digital cameras released since 2012, such as the EOS-1D X, the “Release Cable SR-N3” is not needed.

Cameras Not Compatible with Slave Unit Remote Release

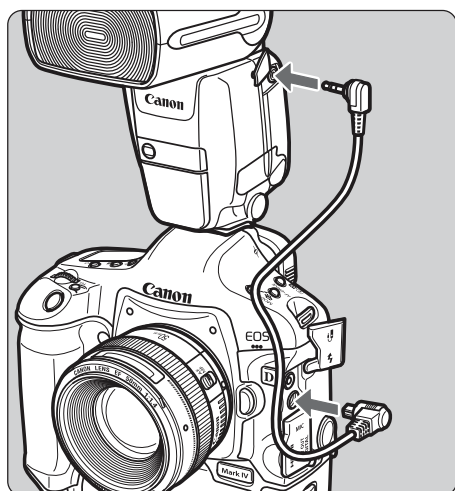

For EOS cameras other than the above that are compatible with E-TTL II/E-TTL autoflash and have an N3 type remote control terminal, the “Release Cable SR-N3” (sold separately) is needed to perform remote release from a slave unit.

As shown in the illustration, use the cable to connect the camera and the 600EX-RT set as the master unit.

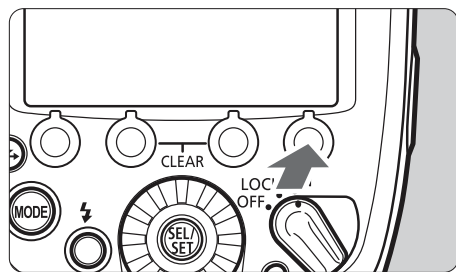

1 Display < MENU 2 >.

- Press the slave unit's function button 4 to display < MENU 2 >.

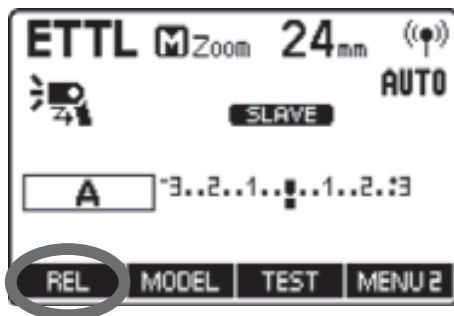

2 Take the picture.

- Press the slave unit's function button 1 < REL >.
- ▶ A release signal is sent from the slave unit to the master unit, and the picture is taken.



- Connect the release cable while the power of the camera and the Speedlite is off.
- Shooting is not possible when focusing with autofocus fails. Focusing manually before performing remote release is recommended.
- The “Release Cable SR-N3” (sold separately) is for an N3 type remote control terminal. It cannot be used with cameras equipped with a remote control terminal other than the N3 type.



- Remote release is performed with “Single shooting” regardless of the camera’s drive mode setting.
- When there are two or more master units, remote release is performed using the master unit with the <LINK> lamp lit in green.

Linked Shooting with Radio Transmission

Linked shooting is a function that automatically releases the shutter of a slave unit camera by linking it to a master unit camera. You can shoot with linked shooting for up to 16 units, including both master units and slave units. This is convenient when you want to shoot a subject from multiple angles at the same time.

To shoot with linked shooting, attach a flash that supports radio transmission wireless shooting or the Speedlite Transmitter ST-E3-RT to the camera.

Note that when using a camera with an N3 type remote control terminal that was released up to 2011 as the “slave unit camera,” the “Release Cable SR-N3” (sold separately) is needed. For details on attaching the cable, see page 68.

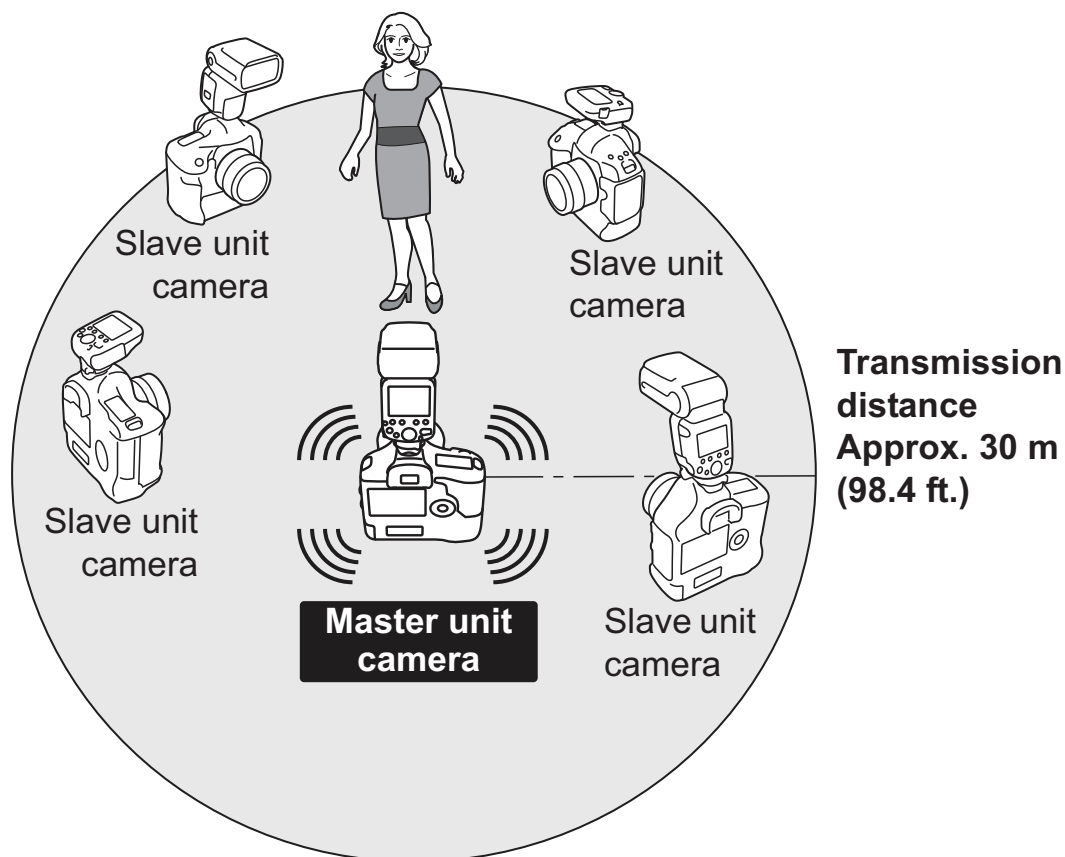

Before performing the operations on the next page, attach a Speedlite or transmitter on all the cameras to be used for linked shooting. For details on the transmitter settings, see the transmitter’s instruction manual.

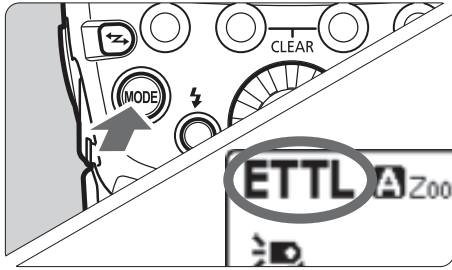

1 Set the flash or transmitter to normal shooting.

- Press the <Z> button to set to normal flash shooting.
- Check that <((P))> (radio transmission) and <⚡> (optical transmission) are not displayed on the LCD panel.

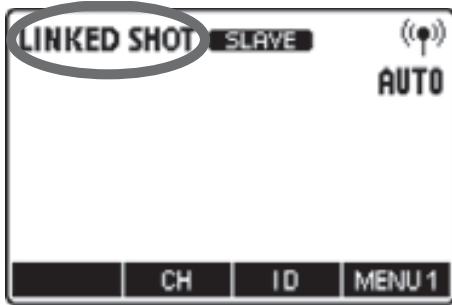

2 Set to linked shooting mode.

- Press the <Z> button continuously until <LINKED SHOT> is displayed on the LCD panel.
 - ▶ Linked shooting mode's "Slave unit" is set.
- Press the <Z> button again to set "Master unit" of the linked shooting mode.

3 Set the channel and ID.

- Set the channel by pressing function button 2 <CH>, and set the ID by pressing function button 3 <ID>.
- For details on setting, see pages 52 to 55.

4 Set the camera's shooting functions.

5 Set all the Speedlites.

- Repeat steps 1 to 4 and set all the Speedlites to “Master unit” or “Slave unit” in the linked shooting mode.
- Set the transmitters used in linked shooting in the same way.
- When pressing the <↔> button to change the setting of a unit from “Slave unit” to “Master unit”, the other Speedlites (or transmitters) that were set as “Master unit” until then automatically switch to “Slave unit”.

6 Set up the slave unit cameras.

- Check that the <LINK> lamp of the slave unit is lit in green.
- Set up all the slave unit cameras within approximately 30 m/98.4 ft. of the master unit camera.

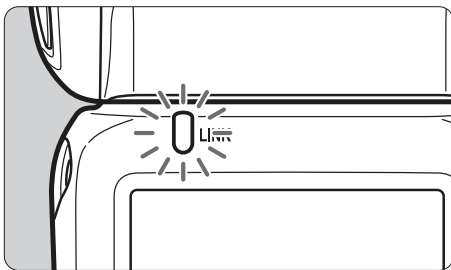

7 Take the picture.

- Check that the <LINK> lamp of the master unit is lit in green and take the picture.
 - ▶ The slave unit cameras are released in coordination with the master unit camera.
 - ▶ After shooting with linked shooting, the <LINK> lamp of the slave unit is briefly lit in orange.



- Shooting with manual focus is recommended for the slave unit cameras. If focus cannot be achieved with autofocus, linked shooting is not possible with the corresponding slave unit camera.
- There is a short time lag between the release of the slave unit camera and the release timing of the master unit camera. Perfectly simultaneous shooting is not possible.
- If you fire multiple flash units at the same time during linked shooting, the appropriate exposure may not be obtained or uneven exposure may result.
- When **[Flash firing]** in **[Flash function settings]** is set to **[Disabled]** (p.44), linked shooting cannot be performed.
- When performing linked shooting in the Live View state with P.Fn-07 set to 0 (p.102), set **[Silent LV shoot.]** on the master camera menu to **[Disabled]**. If **[Mode 1]** or **[Mode 2]** is set, the slave unit cameras will not be released.
- The transmission distance may be shorter depending on the conditions such as the positioning of slave units, the surrounding environment and weather conditions.
- The linked shooting function is the same function as the linked shooting featured by the WFT series of wireless file transmitters. However, linked shooting cannot be performed in combination with the WFT series. Moreover, the release time lag differs from linked shooting performed using the WFT series.



- You can use this function as a master unit remote control for linked shooting without attaching a Speedlite or transmitter to a camera. When function button 1 < **REL** > on the master unit is pressed, all the slave unit cameras are released.
- During linked shooting, the time until auto power off takes effect is 5 min. for both the master and the slave cameras.
- During linked shooting, the Speedlites can be fired (P.Fn-07/p.102).



5

Wireless Flash Shooting: Optical Transmission

This chapter describes wireless flash shooting using optical transmission.

For the accessories required for optical wireless transmission, see the system map (p.104).



When the camera's shooting mode is set to a fully automatic mode or an Image Zone mode, the operations in this chapter are not available. Set the camera's shooting mode to P/Tv/Av/M/B (Creative Zone mode).



- Wireless flash shooting using optical transmission is available with both Speedlite 600EX-RT and Speedlite 600EX.
- The 600EX-RT/600EX attached to the camera is called the master unit, and a 600EX-RT/600EX that is wirelessly controlled is called the slave unit.
- You can also wirelessly control the 600EX-RT/600EX set as the slave unit with an EOS digital camera equipped with a master function, and with the Speedlite Transmitter ST-E2 (sold separately). For details on setting the master unit functions, see the instructions of the camera or transmitter.

⚡ Optical Transmission Wireless Flash Shooting

Using a Canon Speedlite (master/slave) with an optical transmission wireless shooting function makes it easy to shoot with advanced wireless multiple flash lighting, in the same way as normal E-TTL II/E-TTL autoflash shooting.

The system is designed so that the settings of the 600EX-RT/600EX attached to the camera (master) are automatically reflected on the Speedlite that is wirelessly controlled (slave). Therefore, you do not need to operate the slave unit while shooting.

The basic preparations for shooting are shown below. You can then perform wireless E-TTL II/E-TTL autoflash shooting just by setting the master unit to **<ETTL>**.

Positioning and Operation Range (Example of wireless flash shooting)

● Autoflash Shooting Using One Slave Unit (p.81)

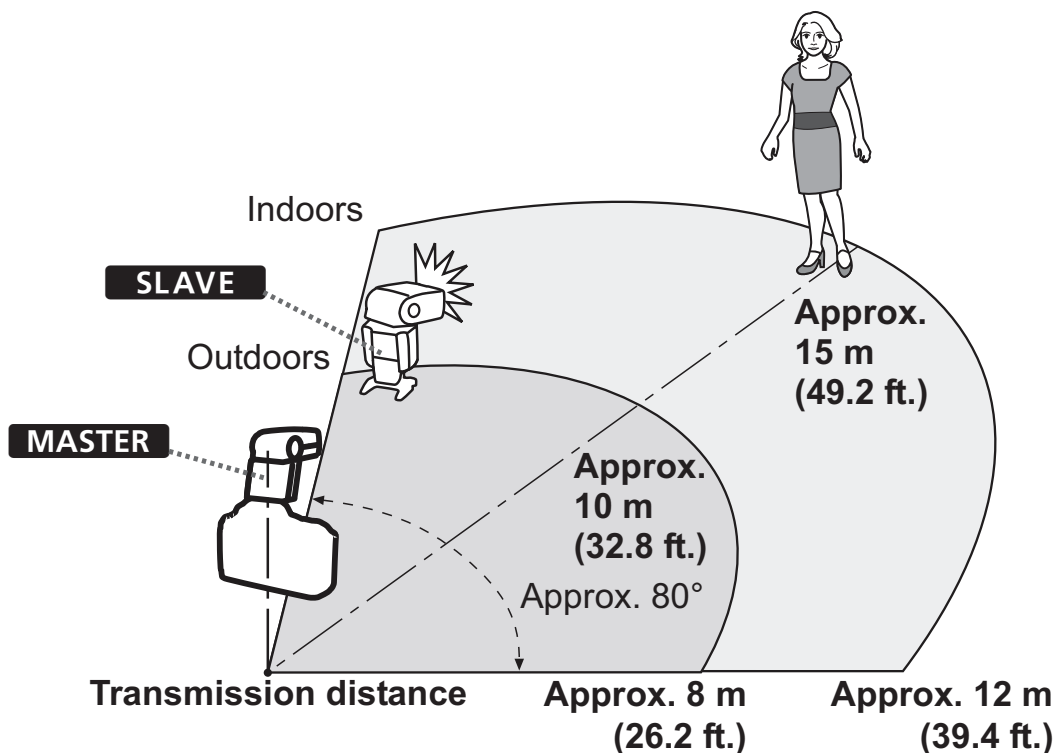

- Position the slave unit using the supplied mini stand (p.11).
- Use the horizontal bounce function (p.27) and point the sensor of the slave unit toward the master unit.
- When shooting indoors, because the transmission signal is reflected off the walls, operation may be possible even with slightly imprecise positioning.

Wireless Multiple Flash Shooting

You can divide the slave units into two or three groups and perform E-TTL II/E-TTL autoflash shooting while changing the flash ratio (factor).

● Autoflash Shooting with Two Slave Groups (p.85)

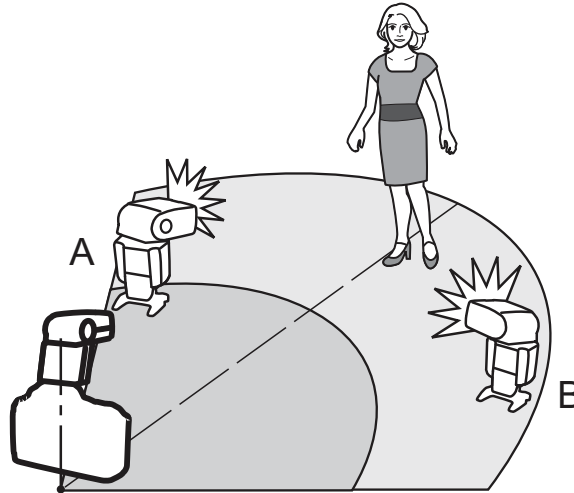

● Autoflash Shooting with Three Slave Groups (p.86)

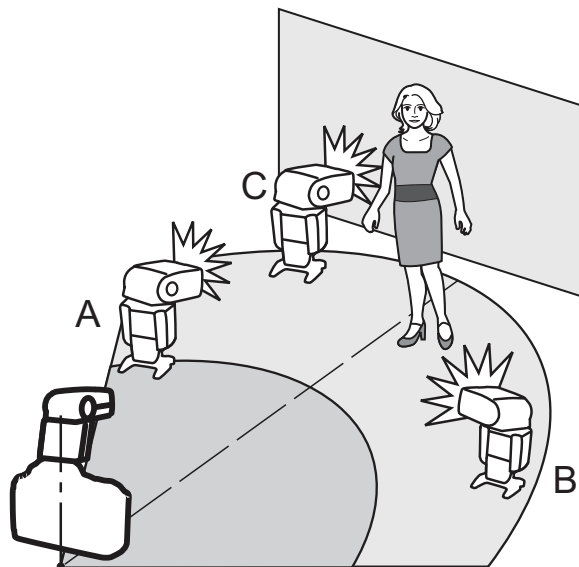

- Before shooting, perform a test flash (p.16) and test shooting.
- To avoid interfering with transmission, do not place any obstacles between the master unit and slave units.

Wireless Settings

To perform optical transmission wireless shooting, set the master unit and slave unit with the following procedure.

Master Unit Setting

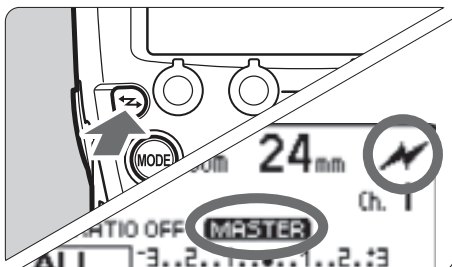

Display <⚡> and < **MASTER** >.

- Press the <⏪> button to display <⚡> (optical transmission) and < **MASTER** >.

Slave Unit Setting

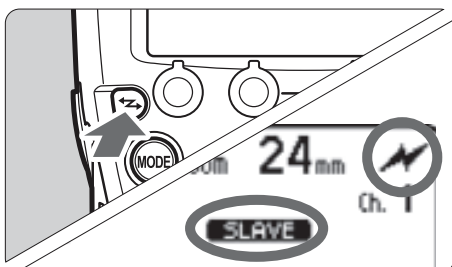

Display <⚡> and < **SLAVE** >.

- Operate and set the flash you want to set as the slave unit.
- Press the <⏪> button to display <⚡> (optical transmission) and < **SLAVE** >.



To perform normal flash shooting, press the <⏪> button to clear the wireless (master/slave) settings.

Transmission Channel Setting

To avoid interference with optical transmission wireless systems used by other photographers, you can change the transmission channel. **Set the same channel for both the master unit and slave unit.**

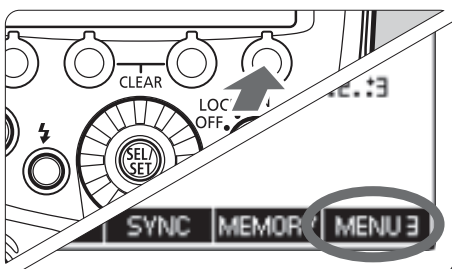



1

Press function button 4.

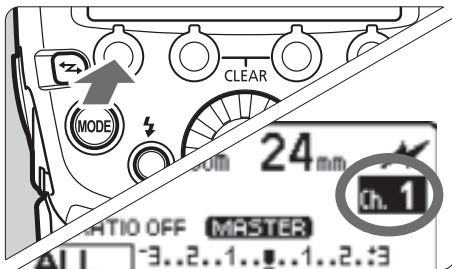
- To set the master unit, press function button 4 to display < **MENU 3** >.
- To set the slave unit, press function button 4 to display < **MENU 2** >.



2 Set a channel.

- Press function button 1 < **CH** >.
- Turn <  > to select a channel from 1 to 4, and press the <  > button.



If the transmission channels of the master unit and slave unit are different, the slave unit does not fire. Set both to the same number.

Master Flash Firing ON/OFF

You can set whether or not to fire, as a wireless flash, the master unit that controls the slave unit. When master flash firing is set to ON, the master unit is fired as a slave unit of firing group A.

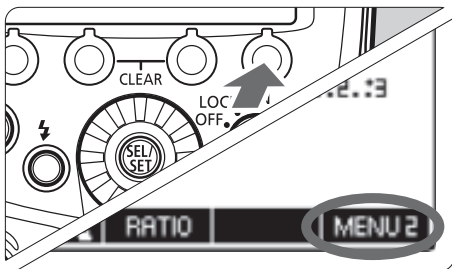

1 Set the < **MENU 2** > display.

- Press function button 4 to display < **MENU 2** >.

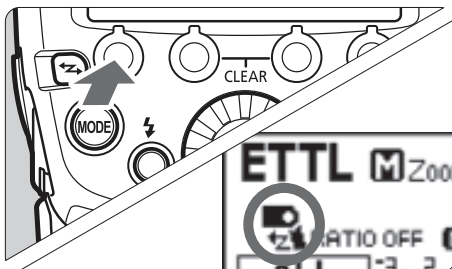

2 Set the master flash firing.

- Press function button 1 < **R/R** > to set the master flash firing to ON or OFF.

 : Master flash firing ON

 : Master flash firing OFF



Even when master flash firing is set to OFF, the flash firing for controlling the slave unit (optical transmission) is performed. Therefore, depending on the shooting conditions, the flash fired for controlling the slave unit may be captured in the picture.

About the Memory Function

You can save the wireless settings in the master unit and slave unit, and recall the settings later. Operate the master unit or slave unit whose settings are to be saved or recalled.

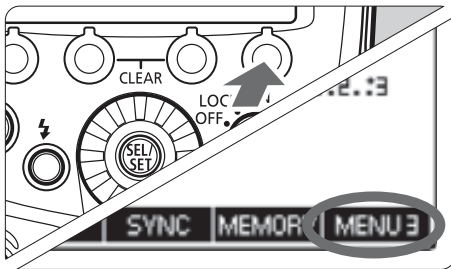

1 Press function button 4.

- On the master unit, press function button 4 to display < **MENU 3** >.
- On the slave unit, press function button 4 to display < **MENU 2** >.

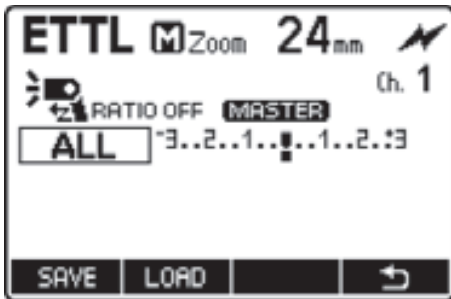

2 Save or load the settings.

- Press function button 3 < **MEMORY** >.

[Save]

- Press function button 1 < **SAVE** >.
- ▶ The settings are saved (stored in the memory).

[Load]

- Press function button 2 < **LOAD** >.
- ▶ The settings that were saved are set.

ETTL: Fully Automatic Wireless Flash Shooting

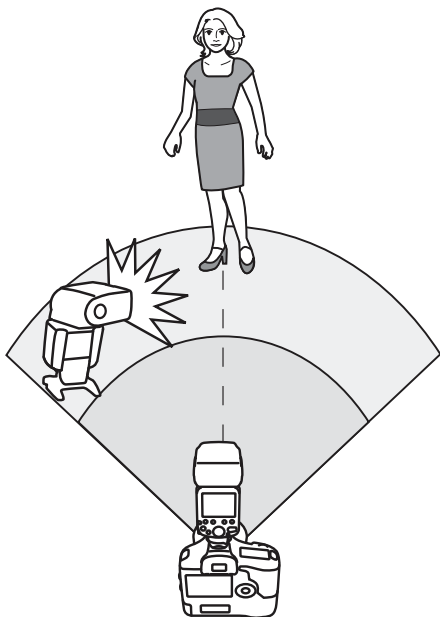

This section describes basic fully automatic wireless shooting when using a 600EX-RT/600EX attached to the camera (master) and a 600EX-RT/600EX wirelessly controlled (slave).

Autoflash Shooting Using One Slave Unit

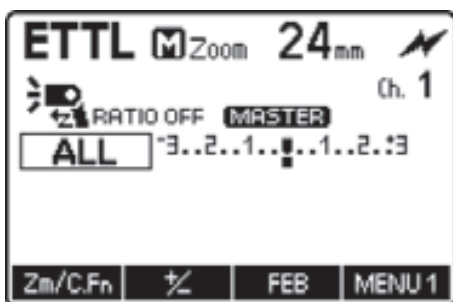

1 Set the master unit.

- Set the 600EX-RT/600EX attached to the camera as the master unit (p.78).
- You can also use a camera equipped with a master function or a Speedlite Transmitter ST-E2 (sold separately) as the master unit.

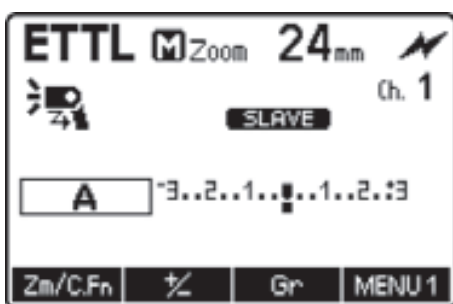

2 Set the slave unit.

- Set the 600EX-RT/600EX to be controlled wirelessly as the slave unit (p.78).
- You can also use other EX Speedlites that are equipped with a slave function.
- A, B or C can be set as the firing group.

3 Check the transmission channel.

- If the channels of the master unit and slave unit are different, set them to the same number (p.78).

4 Position the camera and the flash.

- Position them within the range shown on page 76.

5 Set the flash mode to <ETTL>.

- Press the <MODE> button on the master unit and set the flash mode to <ETTL>.
- The slave unit is set automatically to <ETTL> during shooting via the control from the master unit.
- To also fire the master unit, set the master flash firing to ON (p.79).

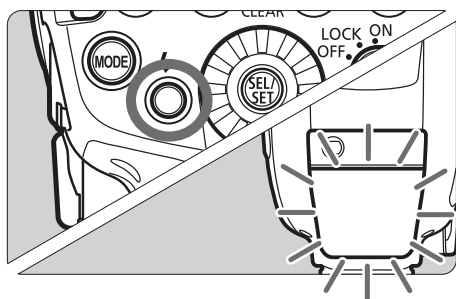

6 Check that the flash is ready.

- Check that the master flash-ready lamp is lit.
- When the slave flash is ready, the AF-assist beam firing area blinks in intervals of 1 second.

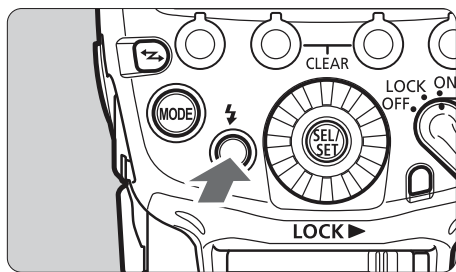

7 Check the operation.

- Press the master unit's test flash button.
- ▶ The slave unit flashes. If the slave unit does not fire, check that it is placed within the operation range.

8 Take the picture.

- Set the camera and take the picture, in the same way as with normal flash shooting.
- ▶ If a standard flash exposure was obtained, the flash exposure confirmation lamp lights for 3 sec.

Autoflash Shooting Using Multiple Slave Units

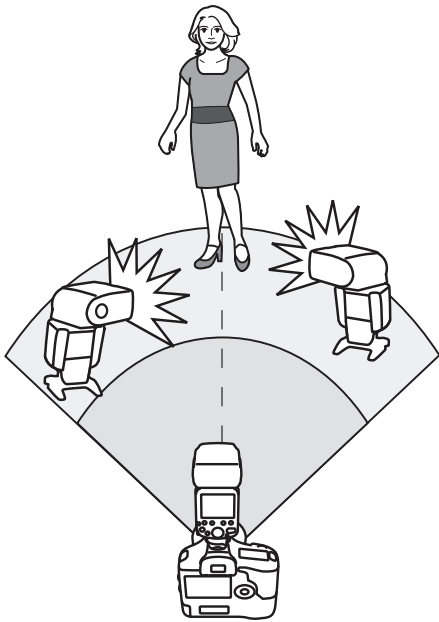

When you need more flash output or you want to perform lighting more easily, you can increase the number of slave units and fire them as a single flash.

To add slave units, use the same procedure as “Autoflash Shooting Using One Slave Unit”. Any firing group (A/B/C) can be set.

When the number of slave units is increased or master flash firing set to ON, automatic control is performed to fire all flashes at the same flash output and ensure that the total flash output results in the standard exposure.





If there is a fluorescent light or PC monitor near a slave unit, the presence of the light source may cause the slave unit to malfunction, causing it to fire inadvertently.



- The master/slave flash coverage is set automatically to 24 mm. You can also set the flash coverage manually.
- You can press the depth-of-field preview button on the camera to fire the modeling flash (p.38).
- If the slave unit's auto power off takes effect, press the master unit's test flash button to turn on the slave unit. Note that the test flash cannot be fired while the camera's metering timer is operating.
- The autoflash system (E-TTL II/E-TTL) depends on the camera used and is set automatically. Note that <ETTL> is displayed on the LCD panel for both systems.
- You can change the time until the slave unit's auto power off takes effect (C.Fn-10/p.98).
- You can set it up so that the AF-assistant beam emitter will not blink when the slave unit recycling is completed (C.Fn-23/p.100).

Using Fully Automatic Wireless Flash



Flash exposure compensation and other settings set on the master unit will also be automatically set in the slave unit(s). You do not need to operate the slave unit. Wireless flash shooting with the following settings can be performed in the same way as in normal flash shooting.

- **Flash exposure compensation** ( /p.22)
- **FEB** ( /p.23)
- **FE lock** (p.24)
- **High-speed sync** ( /p.25)
- **Manual flash** (p.31, 88, 89)
- **Stroboscopic flash** (p.33, 89)



The flash frequency for stroboscopic flash during optical wireless transmission shooting can be set from 1 Hz to 199 Hz (settings from 250 Hz to 500 Hz are not available).



<  >, <  > and <  > are displayed when function button 4 is pressed.

About Master Units

You can use two or more master units. By preparing multiple cameras with master units attached, you can shoot by changing cameras while keeping the same lighting (slave units).

ETTL: Wireless Multiple Flash Shooting with Flash Ratio

Autoflash Shooting with Two Slave Groups

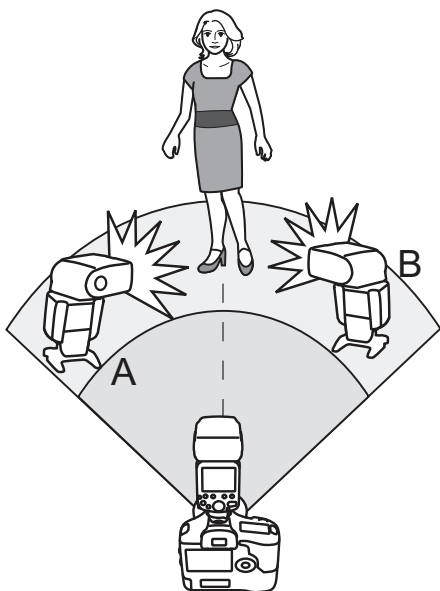

You can divide the slave units into two firing groups, A and B, and adjust the lighting balance (flash ratio) for shooting. The exposure is controlled automatically so that the total flash output of firing groups A and B results in the standard exposure.

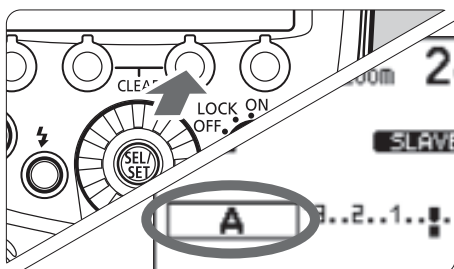

1 Set the firing group of the slave units.

- Operate and set the slave units one by one.
- While **< MENU 1 >** is displayed, press function button 3 **< Gr >** and select **< A >** or **< B >**.
- Set one unit to **< A >** and set the other to **< B >**.

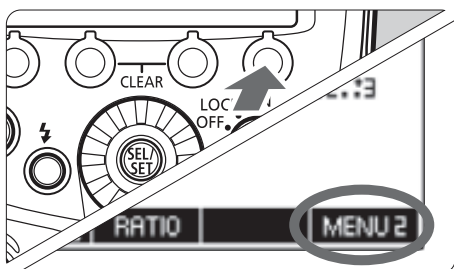

2 Set the **< MENU 2 >** display.

- The operations in steps 2 to 4 are set on the master unit.
- Press function button 4 on the master unit to display **< MENU 2 >**.

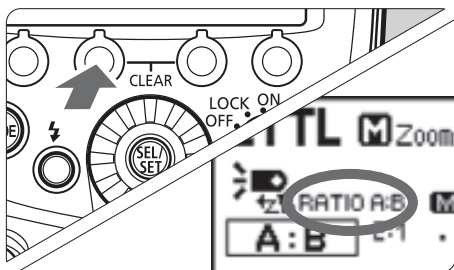

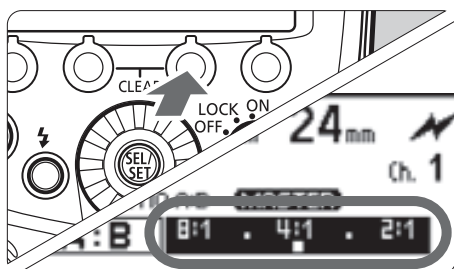

3 Set to **< RATIO A:B >**.

- Press function button 2 **< RATIO >** and set to **< RATIO A:B >**.



4 Set the flash ratio.

- Press function button 3 < **Gr** >.
- Press function button 3 < **A:B** $\frac{1}{2}$ >.
- Turn <  > to set the flash ratio, and press the <  > button.
- Press function button 4 < **↶** > to return to the shooting-ready state.

5 Take the picture.

- ▶ The slave unit flashes at the set flash ratio.

Autoflash Shooting with Three Slave Groups

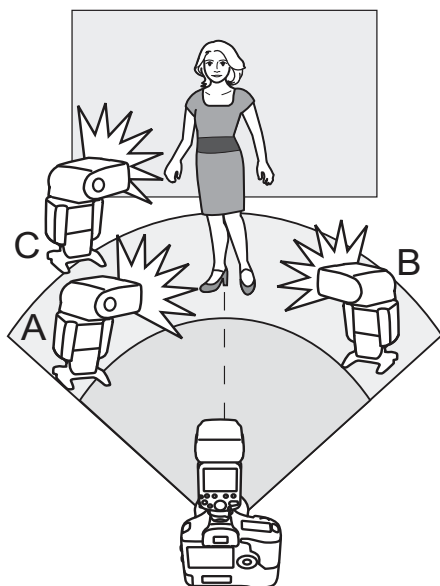

You can add firing group C to firing groups A and B. C is convenient for lighting that eliminates a subject's shadow.

The basic setting method is the same as "Autoflash Shooting with Two Slave Groups".





1 Set slave C.

- Set the slave unit you want to add to flash firing group < **C** > in the same way as step 1 on the preceding page.

2 Set to <RATIO A:B C>.

- Set the master unit to < **RATIO A:B C** > in the same way as steps 2 and 3 on the preceding page.

3 Set flash exposure compensation as required.

- Press function button 3 < **Gr** >, turn <  > and select < **C** >.
- Press function button 3 < **c ±** >.
- Turn <  > to set the flash exposure compensation amount, and press the <  > button.
- Press function button 4 <  > to return to the shooting-ready state.

Slave Group Control

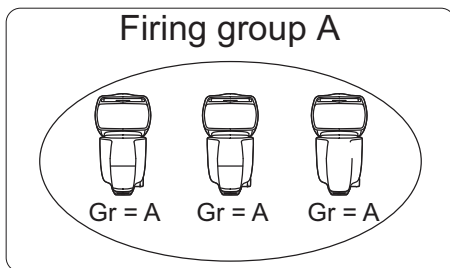

If you need more flash output or wish to perform more sophisticated lighting, you can increase the number of slave units. Simply set an additional slave unit to the firing group (A, B or C) whose flash output you want to increase. There is no restriction on the number of units.

For example, if you set a firing group with three slave units to < **A** >, the three units are treated and controlled as a single firing group A with a large flash output.



- To fire the three firing groups A, B and C at the same time, set < **RATIO A:B C** >. With the < **RATIO A:B** > setting, firing group C does not fire.
- If you shoot with firing group C pointing directly toward the main subject, overexposure may result.
- In some EOS film cameras that support E-TTL autoflash, you cannot perform multiple flash wireless shooting with a flash ratio set ing.



- The flash ratio of 8:1 to 1:1 to 1:8 is equivalent to 3:1 to 1:1 to 1:3 (1/2-stop increment) when converted to number of stops.
- The details of the flash ratio set ings are as follows.



M: Wireless Multiple Flash Shooting with Manual Flash Output

This describes wireless (multiple flash) shooting using manual flash. You can shoot with a different flash output setting for each slave unit (firing group). Set all parameters on the master unit.

1 Set the flash mode to <M>.

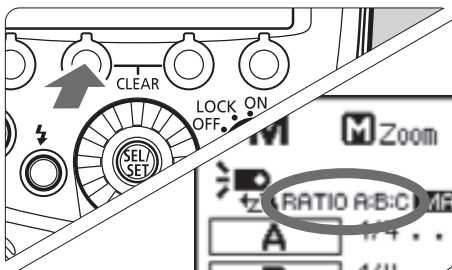

2 Set the number of firing groups.

- While <MENU 1> is displayed, press function button 2 <RATIO> and set the groups to fire.
- The setting changes as follows each time you press the button:
ALL (<RATIO OFF>) →
A/B (<RATIO A:B>) →
A/B/C (<RATIO A:B:C>).

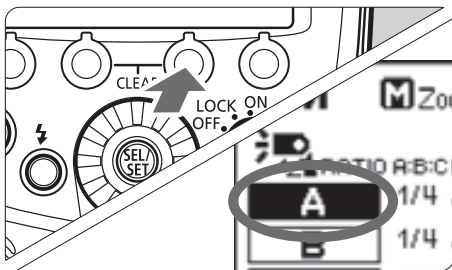

3 Select a firing group.

- Press function button 3 <Gr>, turn <wheel> and select the group for which you want to set the flash output.

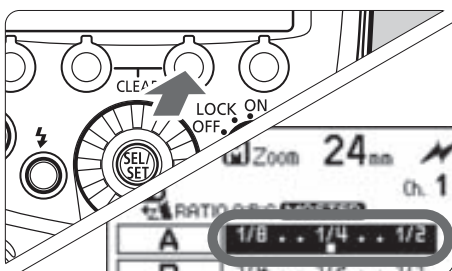

4 Set the flash output.

- Press function button 3 <*1/2>.
- Turn <wheel> to set the flash output, and press the <wheel> button.
- Repeat steps 3 and 4 to set the flash output of all groups.

5 Take the picture.

- ▶ Each group fires at the set flash ratio.



- When ALL <RATIO OFF> is set, set A, B or C as the firing group for the slave units.
- To fire multiple slave units with the same flash output, select ALL <RATIO OFF> in step 2.

Manual Flash/Stroboscopic Flash Setting on a Slave Unit ■

You can directly operate the slave unit to manually set the manual flash or stroboscopic flash. This function is called individual slave. This is convenient when, for example, you use the Speedlite Transmitter ST-E2 (sold separately) to perform wireless manual flash or stroboscopic flash.

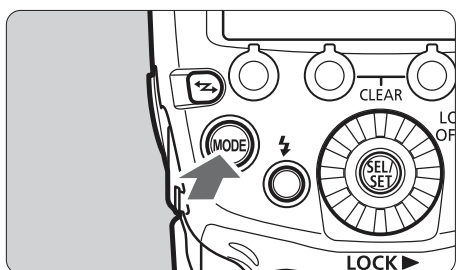

1 Set the slave unit (p.78).

2 Set the individual slave.

- Press the <MODE> button on the slave unit continuously until < **INDIVIDUAL SLAVE** > is displayed.

Manual Flash

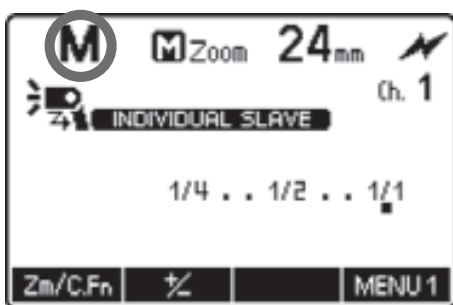

- ▶ The flash mode is set to <M>.
- Set the manual flash output (p.31).

Stroboscopic Flash

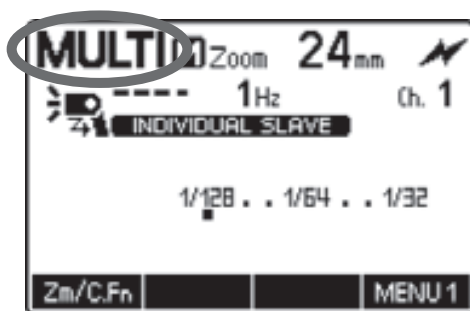

- Press the <MODE> button and set to <MULTI>.
- Set the stroboscopic flash settings (p.33).
- Press the <MODE> button again to return to the normal slave status.

⚠ The flash frequency for stroboscopic flash during optical wireless transmission shooting can be set from 1 Hz to 199 Hz (settings from 250 Hz to 500 Hz are not available).

📄 A slave unit set as an individual slave does not reflect the master unit's flash mode. It fires in the flash mode set on the individual slave.



6

Customizing the Speedlite

This chapter describes how to customize the Speedlite with the Custom Functions (C.Fn) and Personal Functions (P.Fn).

 When the camera's shooting mode is set to a fully automatic mode or an Image Zone mode, the operations in this chapter are not available. Set the camera's shooting mode to **P/Tv/Av/M/B** (Creative Zone mode).

C.Fn/P.Fn: Setting Custom and Personal Functions

You can customize the Speedlite features to suit your shooting preferences with Custom Functions and Personal Functions. Note that the Personal Functions are customizable functions unique to the 600EX-RT/600EX.

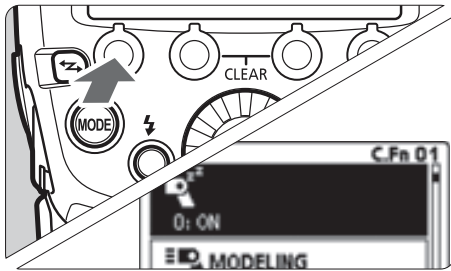

C.Fn: Custom Functions

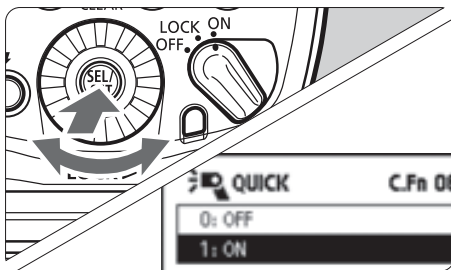

- 1 Display the Custom Functions screen.**
 - Press function button 1 < **Zm/C.Fn** > continuously until the screen is displayed.
 - ▶ The Custom Functions screen is displayed.

- 2 Select an item to set.**
 - Turn <  > to select an item (number) to set.



- 3 Change the setting.**
 - Press the <  > button.
 - ▶ The setting is displayed.
 - Turn <  > to select the setting that you want, and press the <  > button.
 - Press function button 4 < **↶** > to return to the shooting-ready state.



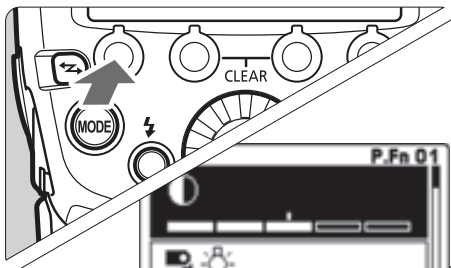













P.Fn: Personal Functions



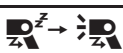





- 1 Display the Personal Functions screen.**
 - After performing step 1 in the Custom Functions procedure, press function button 1 < **P.Fn** >.
 - ▶ The Personal Functions screen is displayed.

- 2 Set the function.**
 - Set the Personal Function in the same way as steps 2 and 3 for the Custom Function.

Custom Function List

| Number | Function | | Page |
|---------|---|-----------------------------------|-------|
| C.Fn-00 |  m/ft | Distance indicator display | p.95 |
| C.Fn-01 |  | Auto power off | |
| C.Fn-02 |  MODELING | Modeling flash | |
| C.Fn-03 |  AUTO CANCEL | FEB auto cancel | p.96 |
| C.Fn-04 |  | FEB sequence | |
| C.Fn-05 | MODE | Flash metering mode | |
| C.Fn-06 |  QUICK | Quickflash with continuous shot | p.97 |
| C.Fn-07 |  TEST | Test firing with autoflash | |
| C.Fn-08 |  AF | AF-assist beam firing | |
| C.Fn-09 |  | Auto zoom for sensor size | p.98 |
| C.Fn-10 |  | Slave auto power off timer | |
| C.Fn-11 |  | Slave auto power off cancel | |
| C.Fn-12 |  | Flash recycle with external power | p.99 |
| C.Fn-13 |  | Flash exposure metering setting | |
| C.Fn-20 |  | Beep | |
| C.Fn-21 |  | Light distribution | p.100 |
| C.Fn-22 |  | LCD panel illumination | |
| C.Fn-23 |  | Slave flash battery check | |

Personal Function List

| Number | Function | | Page |
|---------|---|---|-------|
| P.Fn-01 |  | LCD panel display contrast | p.101 |
| P.Fn-02 |  | LCD panel illumination color: Normal shooting | |
| P.Fn-03 |  | LCD panel illumination color: Master | |
| P.Fn-04 |  | LCD panel illumination color: Slave | |
| P.Fn-05 |  | Color filter auto detection | p.102 |
| P.Fn-06 |  | Wireless button toggle sequence | |
| P.Fn-07 |  | Flash firing during linked shooting | |

Clearing All the Custom/Personal Functions

When function button 2 < **CLEAR** > and then function button 1 < **OK** > are pressed on the Custom Function screen, the Custom Functions which have been set are cleared. Similarly, when the same operations are performed on the personal function screen, the personal functions which have been set are cleared.



- C.Fn-00 is not cleared even when all the Custom Functions have been cleared.
- P.Fn-06 and 07 are not displayed on the Speedlite 600EX.
- When you set the Speedlite Custom Functions from the camera's menu screen and C.Fn-20 to 23 are not displayed, set them with the operation on page 92.



You can set and clear all Speedlite Custom Functions from the camera's menu screen (p.46).

C.Fn: Setting Custom Functions

C.Fn-00: m/ft (Distance indicator display)

You can select the distance indicator display for the LCD panel from meters and feet.

0: m (Meters (m))

1: ft (Feet (ft))



When the effective flash distance exceeds 18 m/60 ft., the right end of the effective flash range on the LCD panel changes to <▶>.

C.Fn-01: (Auto power off)

When the Speedlite is not operated for approx. 90 seconds, the power turns off automatically to save energy. You can disable this function.

0: ON (Enabled)

1: OFF (Disabled)



When the temperature of the flash head rises due to continuous flash firing, the time until auto power off takes effect may increase.

C.Fn-02: MODELING (Modeling flash)

0:  (Enabled (Depth-of-field preview button))

Press the camera's depth-of-field preview button to fire the modeling flash.

1:  (Enabled (Test firing button))

Press the Speedlite's test flash button to fire the modeling flash.

2: / (Enabled (with both buttons))

Press the camera's depth-of-field preview button or the Speedlite's test flash button to fire the modeling flash.

3: OFF (Disabled)

Disables the modeling flash.

C.Fn-03: AUTO CANCEL (FEB auto cancel)

You can set whether or not to cancel FEB automatically after shooting three shots with FEB.

0: ON (Enabled)

1: OFF (Disabled)

C.Fn-04: (FEB sequence)

You can change the order of the FEB sequence: 0: Standard exposure, -: Decreased exposure (darker) and +: Increased exposure (brighter).

0: 0 → - → +

1: - → 0 → +

C.Fn-05: MODE (Flash metering mode)

You can change the automatic flash metering mode for flash shooting.

0: E-TTL II

1: TTL

2: Ext.A (External metering: Auto)

3: Ext.M (External metering: Manual)



When using an EOS digital camera or EOS REBEL T2/EOS 300X, do not set to 1. Depending on the model, the flash metering may not be controlled correctly; for example, the flash may not fire, or it may always fire at full power. Also, wireless flash shooting can no longer be performed.



- 1 is the setting for Type-B EOS film cameras.
- When using a Type-B camera, you cannot perform E-TTL II/E-TTL autoflash shooting even when 0 is set.

C.Fn-06:  QUICK (Quickflash with continuous shot)

You can set whether or not to fire the flash in continuous shooting while the flash-ready lamp is lit green (before the flash is fully charged).

0: OFF (Disabled)

1: ON (Enabled)



When Quick Flash is fired during continuous shooting, underexposure may occur since the effective flash range becomes shorter. Setting 1 is recommended only when you want to shorten the effective flash range during short distance shooting.

C.Fn-07:  TEST (Test firing with autoflash)

You can change the flash output when firing the test flash in E-TTL II/ E-TTL/TTL autoflash mode.

0: 1/32 (1/32)

1: 1/1 (Full output)

C.Fn-08:  AF (AF-assist beam firing)

0: ON (Enabled)

1: OFF (Disabled)

The AF-assist beam is not fired from the Speedlite.

C.Fn-09: (Auto zoom for sensor size)

0: ON (Enabled)

When the flash coverage is set to “Automatic <A>”, it is automatically adjusted to match the image sensor size of the EOS digital camera being used. When mounted on a supported camera, <> is displayed on the LCD panel.

1: OFF (Disabled)

The flash coverage is not automatically adjusted to match the image sensor size.

C.Fn-10: (Slave auto power off timer)

You can change the time until the slave unit’s auto power off takes effect. Note that when the slave unit’s auto power off takes effect, <> is displayed on the LCD panel. Set this function on each slave unit.

0: 60min (60 minutes)

1: 10min (10 minutes)

C.Fn-11: (Slave auto power off cancel)

When you press the test flash button of master unit, you can turn on the power of slave units in the auto power off status. You can change the time within which slave units in the auto power off status accept this function.

0: 8h (Within 8 hours)

1: 1h (Within 1 hour)



C.Fn-12:  (Flash recycle with external power)**0:  (External & internal power)**

Charges in parallel using both internal power and external power.

1:  (External power only)

Internal power is needed to control the Speedlite. By using only external power for charging, you can minimize the depletion of the internal power.

C.Fn-13:  (Flash exposure metering setting)**0:  (Speedlite button and dial)****1:  (Speedlite dial only)**

You can perform flash exposure compensation by directly turning <  >, without pressing the <  > button.

C.Fn-20:  (Beep)

You can enable a beep to sound when the Speedlite is fully charged, or when a slave unit is fully charged during radio wireless transmission flash shooting.

Note that when set to **1**, a beep will sound as a warning when the flash firing restriction is activated due to a temperature increase in the flash head.

0: OFF (Disabled)**1: ON (Enabled)**

C.Fn-21: / / (Light distribution)

You can change the light distribution (flash coverage) of the Speedlite in relation to the shooting angle of view when the flash coverage is set to “Automatic (A)”.

0: (Standard)

The optimum flash coverage for the shooting angle of view is set automatically.

1: (Guide number priority)

Although the periphery of the picture is slightly darker than the 0 setting, this is convenient when you want to give priority to the flash output. The flash coverage is set automatically to a slightly more telephoto position than the actual shooting angle of view. The flash icon on the LCD panel changes to .

2: (Even coverage)

Although the shooting distance is slightly shorter than the 0 setting, this is convenient when you want to minimize light fall off at the periphery of the picture. The flash coverage is set automatically to a slightly wider position than the actual shooting angle of view. The flash icon on the LCD panel changes to .

C.Fn-22: (LCD panel illumination)

When a button or dial is operated, the LCD panel illuminates. You can change this illumination setting.

0: 12sec (On for 12 sec.)

1: OFF (Disable panel illumination)

2: ON (Illumination always on)

C.Fn-23: (Slave flash battery check)

When the slave unit is fully charged during wireless flash shooting, the AF-assist beam emitter of the slave unit blinks. You can disable this operation. Set this function on each slave unit.

0: / (AF-assist beam, lamp)

1: (lamp)

P.Fn: Setting Personal Functions

P.Fn-01: (LCD panel display contrast)

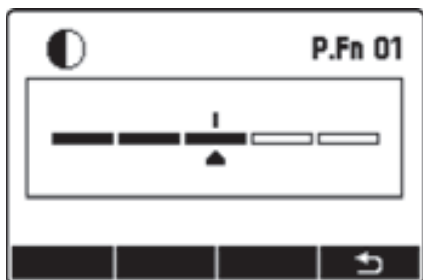

You can adjust the contrast of the LCD panel in 5 levels.

P.Fn-02: (LCD panel illumination color: Normal shooting)

You can select the color of the LCD panel illumination during normal shooting (on-camera flash).

0: GREEN (Green)

1: ORANGE (Orange)

P.Fn-03: (LCD panel illumination color: Master)

During wireless flash shooting using radio or optical transmission or linked shooting: You can select the color of the LCD panel illumination to be used when the Speedlite is set as the master unit.

0: GREEN (Green)

1: ORANGE (Orange)

P.Fn-04: (LCD panel illumination color: Slave)

During wireless flash shooting using radio or optical transmission or linked shooting: You can select the color of the LCD panel illumination to be used when the Speedlite is set as the slave unit.

0: ORANGE (Orange)

1: GREEN (Green)

P.Fn-05: (Color filter auto detection)

0: AUTO (Auto)

Set this option when the supplied color filters are used. They are automatically detected.

1: OFF (Disable)

Set this option when you use commercially-available filters. The color filter will not be automatically detected.

P.Fn-06: (Wireless button toggle sequence)

You can change the settings that can be selected when the wireless button is pressed. P.Fn-06 is not displayed on the Speedlite 600EX.

0: OFF → → (Normal → Radio → Optical)

The setting changes in the order: Normal shooting → Radio transmission: Master → Radio transmission: Slave → Optical transmission: Master → Optical transmission: Slave.

1: OFF ↔ (Normal ↔ Radio)

The setting changes in the order: Normal shooting → Radio transmission: Master → Radio transmission: Slave.

2: OFF ↔ (Normal ↔ Optical)

The setting changes in the order: Normal shooting → Optical transmission: Master → Optical transmission: Slave.

P.Fn-07: LINKED SHOT (Flash firing during linked shooting)

When shooting with the linked shooting function (p.70), you can set whether or not to fire the flash mounted on the camera. Set it for each flash to be used in linked shooting. P.Fn-07 is not displayed on the Speedlite 600EX.

0: OFF (Disabled)

The flash does not fire during linked shooting.

1: ON (Enabled)

The flash fires during linked shooting.



If you fire multiple flash units at the same time during the linked shooting, the appropriate exposure may not be obtained or uneven exposure may result.

7

Reference

This chapter includes a system map, FAQ, and a description on using the Speedlite with a Type-B camera.

600EX-RT/600EX System

Wireless Flash Shooting

Radio transmission

Speedlite/Transmitter with master function

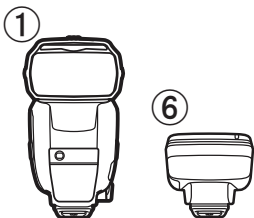

Speedlite with slave function



Optical transmission

Camera/Speedlite/Transmitter with master function

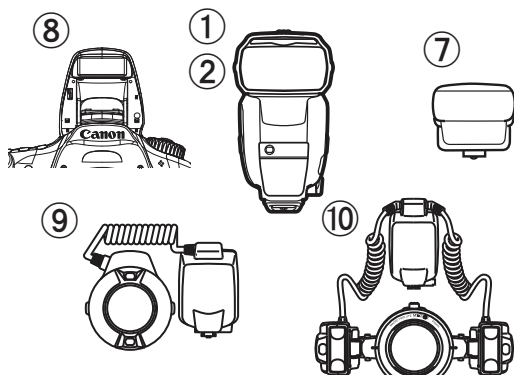

Speedlite with slave function

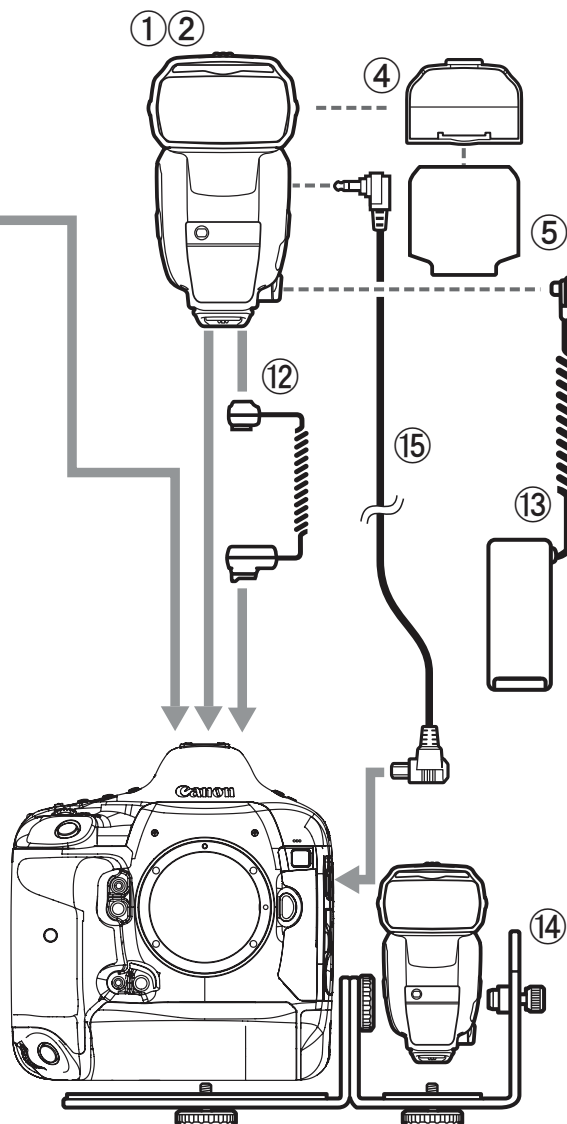
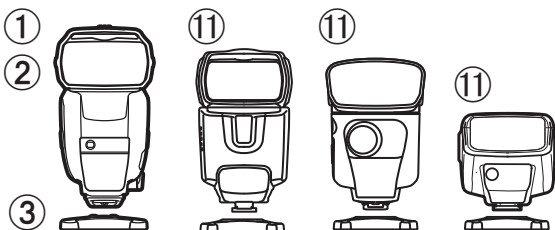

- ① **Speedlite 600EX-RT**
- ② **Speedlite 600EX** (Cannot be used with ⑮)
- ③ **Mini stand** (supplied with 600EX-RT/600EX)
- ④ **Color filter holder SCH-E1** (supplied with 600EX-RT/600EX)

- ⑤ **Color filter set SCF-E1** (supplied with 600EX-RT/600EX)
- ⑥ **Speedlite Transmitter ST-E3-RT**
Transmitter for radio transmission wireless control of Speedlites set as slave units.
- ⑦ **Speedlite Transmitter ST-E2**
Transmitter for optical transmission wireless control of Speedlites set as slave units.
- ⑧ **EOS camera with wireless master function**
You can set as the master unit an EOS digital camera with an optical transmission wireless master function using the built-in flash.
- ⑨ **Macro Ring Lite MR-14EX** / ⑩ **Macro Twin Lite MT-24EX**
Flash for macro photography.
- ⑪ **Speedlite with optical transmission wireless slave function**
580EX II, 580EX, 550EX, 430EX II, 430EX, 420EX, 320EX, 270EX II
- ⑫ **Off-Camera Shoe Cord OC-E3**
Enables the 600EX-RT/600EX to be connected to the camera up to 60 cm / 2 ft. away.
- ⑬ **Compact Battery Pack CP-E4**
A small and lightweight external power source with excellent portability. Equipped with dust and water resistance equivalent to 600EX-RT/600EX.
- ⑭ **Speedlite Bracket SB-E2**
- ⑮ **Release Cable SR-N3**
If you connect the 600EX-RT using this cable to an EOS camera which is compatible with E-TTL II/E-TTL autoflash, has an N3 type remote control terminal and was released up to 2011, you can release the shutter from the slave unit (p.68) or perform linked shooting using the unit as a slave unit camera (p.70) during radio transmission wireless shooting.



 For external power, use the ⑬ Compact Battery Pack CP-E4. Using an external power source other than Canon may result in a malfunction.

Flash Firing Restriction due to Temperature Increase

When continuous flash, stroboscopic flash or modeling flash is repeatedly fired in short intervals, the temperature of the flash head may increase. When repeated firings of the flash exceed the values shown in the table below, the flash firing restriction activates automatically to avoid degrading and damaging the flash head due to overheating. While flash firing is restricted, a warning icon is displayed to indicate the increase in temperature, and the recycling time is automatically set to an interval between approx. 8 and 20 sec.

Temperature Increase Warning

When the internal temperature of the Speedlite increases, a warning icon is displayed in two levels.

| Display | Level 1 (Recycling Time: Approx. 8 sec.) | Level 2 (Recycling Time: Approx. 20 sec.) |
|------------------------|---|---|
| Icon |  |  |
| LCD panel illumination | Red (turned on) | Red (blinking) |

Number of Continuous Flashes and Rest Time

The following table shows the number of continuous flashes until the warning is displayed, and the necessary rest time until normal flash shooting can be performed.

| Function | Number of Continuous Flashes Until Warning Display (Level 1) (Guideline) | Necessary Rest Time (Guideline) |
|-------------------------|--|---------------------------------|
| Continuous flash (p.13) | 48 times or more | 10 min. or longer |
| Modeling flash (p.38) | | |

* At full flash output with flash coverage of 14 mm/20 mm

* With external power source, the number of flashes will be two thirds (32 times or more)



- The number of continuous flashes until warning display during stroboscopic flash varies depending on the flash output.
- For the recommended number of flash firings, see the sections on continuous flashes (p.13), stroboscopic flashes (p.33) and modeling flashes (p.38).
- If you change the batteries after firing many flashes continuously, be aware that the batteries might be hot.
- When C.Fn-20 is set to 0 (p.99), the warning beep does not sound even when flash firing is restricted.

Troubleshooting Guide

If a problem occurs with the flash, first refer to this Troubleshooting Guide. If this Troubleshooting Guide does not resolve the problem, contact your dealer or nearest Canon Service Center.

● Normal Shooting

Power does not turn on or the flash does not fire.

- Make sure that the batteries are installed in the correct orientation (p.14).
- Insert the mounting foot into the camera's hot shoe all the way, slide the lock lever to the right, and secure the Speedlite to the camera (p.15).
- If the flash recycling time takes 30 sec. or longer, replace the batteries (p.14).
- Even when using external power, insert batteries into the Speedlite (p.14).
- If the electrical contacts of the Speedlite and camera are dirty, clean the contacts (p.6).

The power turns off by itself.

- The Speedlite's auto power off has activated. Press the shutter button halfway, or press the test flash button (p.16).

The picture is underexposed or overexposed.

- If there was a highly reflective object (glass window, etc.) in the picture, use FE lock (p.24).
- If the subject looks very dark or very bright, set flash exposure compensation (p.22).
- When high-speed sync is set, the effective flash range is shorter. Move closer to the subject (p.25).

The bottom of the picture looks dark.

- You were too close to the subject. Move away from the subject.
- When shooting within 1 m (3.3 ft.) of the subject, set the bounce position down by 7°.
- Remove the lens hood if attached.

The picture periphery looks dark.

- Set the flash coverage to the automatic setting (p.29).
- When using the manual setting for the flash coverage, set a flash coverage that is wider than the shooting angle of view (p.30).
- Check that C.Fn-21-1 is not set (p.100).

The picture is very blurred.

- When the shooting mode is set to <Av> and the scene is dark, slow sync is enabled automatically (the shutter speed becomes slower). Use a tripod, or set the shooting mode to <P> or fully automatic mode (p.19). Note that you can also set the sync speed in [**Flash sync. speed in Av mode**] (p.44).

The flash coverage is not set automatically.

- Insert the mounting foot into the camera's hot shoe all the way, slide the lock lever to the right, and secure the Speedlite to the camera (p.15).
- Set the flash coverage to <A> (Automatic) (p.29).

● Radio Transmission Wireless Shooting

Wireless shooting does not work.

- When using a Speedlite 600EX (without radio transmission function), wireless shooting using radio transmission is not available. Use optical transmission wireless shooting.

The slave unit does not fire.

- Set the master unit to <((P))> <**MASTER**> and set the slave unit to <((P))> <**SLAVE**> (p.52).
- Set the transmission channels and wireless radio IDs of the master unit and slave unit to the same numbers (p.52 - 54).
- Check that the slave unit is within the transmission range of the master unit (p.48).
- The camera's built-in flash cannot be used as the master unit in radio transmission wireless shooting.

The slave unit does not fire or unexpectedly fires at full output.

- Run the channel scan and set the channel with the best radio reception signal (p.54).
- Position the slave unit in clear view of the master unit, without obstacles between them.
- Face the slave unit's front toward the master unit.

Pictures are overexposed.

- When using autoflash shooting with three firing groups A, B and C, do not fire with firing group C pointed toward the main subject (p.63).
- When shooting with a different flash mode setting for each firing group, do not fire with multiple firing groups set to <**ETTL**> or <**Ext.A**> pointed toward the main subject (p.67).

<!Tv> is displayed.

- Set the shutter speed 1 stop slower than the flash sync speed (p.51).

Cannot release from a slave unit.

- When an EOS camera which was released up to 2011, has an N3 type remote control terminal and is compatible with E-TTL II/E-TTL autoflash is used to perform remote release from a slave unit or when it has been set as the slave unit during linked shooting, the “Release Cable SR-N3” (sold separately) is necessary (p.68, 70, 104).

● **Linked Shooting**

Uneven exposure occurs./The standard exposure is not obtained.

- If you fire multiple flash units at the same time during linked shooting, the appropriate exposure may not be obtained or uneven exposure may result. It is recommended to set only one Speedlite to fire or to use self-timer to space out the timing of the flashes.

● Optical Transmission Wireless Shooting

The slave unit does not fire.

- Set the master unit to <⚡> <MASTER> and set the slave unit to <⚡> <SLAVE> (p.78).
- Set the transmission channels of the master unit and slave unit to the same numbers (p.78).
- Check that the slave unit is within the transmission range of the master unit (p.76).
- Point the wireless sensor on the slave unit toward the master unit (p.76).
- If the master unit and slave unit are too close, the transmission may not operate properly.
- When using the camera's built-in flash as the master unit, raise the camera's built-in flash, and set the wireless function in [**Built-in flash func. setting**] on the camera's menu screen.

The master unit's flash fires.

- Even when master flash firing is set to OFF <OFF>, the master flash fires a small flash to control the slave unit with optical transmission (p.79).

Pictures are overexposed.

- When using autoflash shooting with three firing groups A, B and C, do not fire with firing group C pointed toward the main subject (p.87).

Specifications

● Type

| | |
|---------------------|---|
| Type: | On-camera, E-TTL II/E-TTL/TTL autoflash Speedlite |
| Compatible cameras: | Type-A EOS cameras (E-TTL II/E-TTL autoflash) Type-B EOS cameras (TTL autoflash) |

● Flash Head

| | |
|---|---|
| Guide No.: | Approx. 60/197 (at 200 mm flash coverage, ISO 100 in meters/feet) |
| Flash coverage: | 20 - 200 mm (14 mm when using wide panel) <ul style="list-style-type: none">• Automatic setting (Automatically sets the flash coverage depending on the shooting angle of view and the image sensor size.)• Manual setting |
| Bounce: | 90° up, 7° down, 180° left/right |
| Flash time: | Normal flash: 1.8 ms or less, Quick Flash: 2.3 ms or less |
| Color temperature information transmission: | Flash color temperature information transmitted to camera when flash is fired |
| Color filter: | Can be used |

● Exposure Control

| | |
|--|---|
| Exposure control system: | E-TTL II/E-TTL/TTL autoflash, auto/manual external flash metering, manual flash, stroboscopic flash |
| Effective flash range: (With EF50 mm f/1.4 lens at ISO 100) | Normal flash: approx. 0.5 - 30 m (1.6 - 98.4 ft.) Quick Flash: min.: approx. 0.5 - 12 m (1.6 - 39.4 ft.) max.: approx. 0.5 - 21 m (1.6 - 68.9 ft.) High-speed sync: approx. 0.5 - 15 m (1.6 - 49.2 ft.) (at 1/250 sec.) |
| Flash exposure compensation: | ±3 stops in 1/3- or 1/2-stop increments |
| FEB: | ±3 stops in 1/3- or 1/2-stop increments (when used with flash exposure compensation) |
| FE lock: | Press the camera's <M-Fn>, <FEL> or <✳> button |
| High-speed sync: | Provided * During radio transmission wireless shooting, high-speed sync is possible only with EOS digital cameras released since 2012. |
| Manual flash: | 1/128 - 1/1 power (1/3-stop increments) |
| Stroboscopic flash: | Provided (1 - 500 Hz) * 1 Hz to 199 Hz during optical transmission wireless shooting |
| Flash exposure confirmation: | Flash exposure confirmation lamp lights |
| Modeling flash: | Fired with camera's depth-of-field preview button |

● Flash Recycling

| | |
|---------------------------|--|
| Recycling time: | Normal flash: approx. 0.1 - 5.5 sec., Quick Flash: approx. 0.1 - 3.3 sec. * When using AA/LR6 alkaline batteries |
| Flash-ready lamp display: | Lit in red: normal flash available Lit in green: Quick Flash available |

● AF-assist Beam

| | |
|-----------------------|---|
| Compatible AF system: | 1 - 61 AF points (28 mm or longer focal length) * During viewfinder shooting, and Quick Mode during Live View shooting or movie shooting supported |
| Effective range: | At center: approx. 0.6 - 10 m / 2 0 - 32.8 ft., periphery: approx. 0.6 - 5 m / 2 0 - 16.4 ft. |

● Radio Transmission Wireless Function (600EX-RT only)

| | |
|----------------------------|--|
| Frequency: | 2405 - 2475 MHz |
| Modulation system: | Primary modulation: OQPSK, secondary modulation: DS-SS |
| Wireless settings: | Master/slave |
| Channel: | Auto, Ch. 1 - 15 |
| Wireless radio ID: | 0000 - 9999 |
| Slave unit control: | Up to 5 groups (A/B/C/D/E), up to 15 units |
| Transmission distance: | Approx. 30 m / 98.4 ft. * When there are no obstacles or obstructions between the master unit and slave unit, and no radio interference with other devices * The transmission distance may be shorter depending on the relative positions of the units, surrounding environment and weather conditions |
| Flash ratio control: | 1:8 - 1:1 - 8:1, power 1/2-stop increments |
| Slave flash battery check: | <⚡> icon lights on the master unit's LCD panel, slave unit's AF-assist beam emitter blinks, flash-ready lamp lights |
| Linked shooting: | Provided |

● Optical Transmission Wireless Function

| | |
|------------------------------|--|
| Connection method: | Optical pulse |
| Wireless settings: | Master/slave |
| Channel: | Ch. 1 - 4 |
| Slave unit control: | Up to 3 groups (A/B/C) |
| Transmission distance: | Indoors: approx. 0.7 - 15 m / 2.3 - 49.2 ft., outdoors: approx. 0.7 - 10 m / 2.3 - 32.8 ft. (at the front) ±40° horizontally and ±30° vertically, facing the master unit |
| Flash ratio control: | 1:8 - 1:1 - 8:1, power 1/2-stop increments |
| Slave flash battery display: | Slave unit's AF-assist beam emitter blinks, flash-ready lamp lights |

● Customizable Functions

Custom Functions: 18
Personal Functions: 600EX-RT: 7 / 600EX: 5

● Power Source

Speedlite power source: 4 AA/LR6 alkaline batteries
* AA/LR6 Ni-MH and lithium batteries also usable

Battery life (Flash count): Approx. 100 - 700 flashes
* When using AA/LR6 alkaline batteries

Radio transmission wireless shooting time: Approx. 9 continuous hours
* When Master flash firing OFF, using AA/LR6 alkaline batteries

Optical transmission wireless shooting count: Approx. 1500 times
* When Master flash firing OFF, using AA/LR6 alkaline batteries

Power saving: Power off after approx. 90 sec. of idle operation
* When set as slave unit: 60 min.
* When set as radio transmission wireless master unit and linked shooting: 5 min.

External power: Compact Battery Pack CP-E4 can be used

● Dimensions and Weight

Dimensions: Approx. 79.7 (W) x 142.9 (H) x 125.4 (D) mm / 3.1 x 5.6 x 4.9 in. (excluding the dust- and water-resistant adapter)

Weight: Approx. 425 g / 15.0 oz.
* Speedlite only, excluding batteries.

- All specifications above are based on Canon's testing standards.
- Product specifications and external appearance are subject to change without notice.

Guide Number (ISO 100 in meters/feet)

Normal Flash (Full Output)/Quick Flash

| Flash Coverage (mm) | 14 | 20 | 24 | 28 | 35 | 50 |
|----------------------------|------------------------------------|---------|---------|---------|----------|----------|
| Normal Flash (Full Output) | 15/49.2 | 26/85.3 | 28/91.9 | 30/98.4 | 36/118.1 | 42/137.8 |
| Quick Flash | Same as 1/2 to 1/6 of manual flash | | | | | |

| Flash Coverage (mm) | 70 | 80 | 105 | 135 | 200 |
|----------------------------|------------------------------------|----------|----------|----------|----------|
| Normal Flash (Full Output) | 50/164 | 53/173.9 | 58/190.3 | 59/193.6 | 60/196.9 |
| Quick Flash | Same as 1/2 to 1/6 of manual flash | | | | |

Manual Flash

| Flash Output | Flash Coverage (mm) | | | | | |
|--------------|---------------------|-----------|----------|-----------|-----------|-----------|
| | 14 | 20 | 24 | 28 | 35 | 50 |
| 1/1 | 15/49.2 | 26/85.3 | 28/91.9 | 30/98.4 | 36/118.1 | 42/137.8 |
| 1/2 | 10.6/34.8 | 18.4/60.4 | 19.8/65 | 21.2/69.6 | 25.5/83.7 | 29.7/97.4 |
| 1/4 | 7.5/24.6 | 13/42.7 | 14/45.9 | 15/49.2 | 18/59.1 | 21/68.9 |
| 1/8 | 5.3/17.4 | 9.2/30.2 | 9.9/32.5 | 10.6/34.8 | 12.7/41.7 | 14.8/48.6 |
| 1/16 | 3.8/12.5 | 6.5/21.3 | 7/23 | 7.5/24.6 | 9/29.5 | 10.5/34.4 |
| 1/32 | 2.7/8.9 | 4.6/15.1 | 4.9/16.1 | 5.3/17.4 | 6.4/21 | 7.4/24.3 |
| 1/64 | 1.9/6.2 | 3.3/10.8 | 3.5/11.5 | 3.8/12.5 | 4.5/14.8 | 5.3/17.4 |
| 1/128 | 1.3/4.3 | 2.3/7.5 | 2.5/8.2 | 2.7/8.9 | 3.2/10.5 | 3.7/12.1 |

| Flash Output | Flash Coverage (mm) | | | | |
|--------------|---------------------|-----------|-----------|------------|------------|
| | 70 | 80 | 105 | 135 | 200 |
| 1/1 | 50/164 | 53/173.9 | 58/190.3 | 59/193.6 | 60/196.9 |
| 1/2 | 35.4/116.1 | 37.5/123 | 41/134.5 | 41.7/136.8 | 42.4/139.1 |
| 1/4 | 25/82 | 26.5/86.9 | 29/95.1 | 29.5/96.8 | 30/98.4 |
| 1/8 | 17.7/58.1 | 18.7/61.4 | 20.5/67.3 | 20.9/68.6 | 21.2/69.6 |
| 1/16 | 12.5/41 | 13.3/43.6 | 14.5/47.6 | 14.8/48.6 | 15/49.2 |
| 1/32 | 8.8/28.9 | 9.4/30.8 | 10.3/33.8 | 10.4/34.1 | 10.6/34.8 |
| 1/64 | 6.3/20.7 | 6.6/21.7 | 7.3/24 | 7.4/24.3 | 7.5/24.6 |
| 1/128 | 4.4/14.4 | 4.7/15.4 | 5.1/16.7 | 5.2/17.1 | 5.3/17.4 |

Using with a Type-B Camera

This section describes the available and unavailable functions when using the Speedlite 600EX-RT/600EX with a Type-B camera (EOS film camera supporting TTL autoflash).

When the Speedlite 600EX-RT/600EX is used with autoflash with a Type-B camera, <**TTL**> is displayed on the Speedlite's LCD panel.

Functions available with Type-B cameras

- TTL autoflash
- Speedlite flash exposure compensation
- FEB
- Manual flash
- Stroboscopic flash
- Second-curtain sync
- Manual external flash metering
- Wireless flash shooting with optical transmission
 - Manual flash
 - Stroboscopic flash

Functions not available with Type-B cameras

- E-TTL II/E-TTL autoflash
- FE lock
- High-speed sync
- Auto external flash metering
- Wireless flash shooting with radio transmission
- Wireless flash shooting with optical transmission
 - Autoflash shooting
 - Flash ratio control
- Modeling flash

The apparatus shall not be exposed to dripping or splashing.
Batteries shall not be exposed to excessive heat such as sunshine, fire or the like.
Dry batteries shall not be subjected to charging.



European Union (and EEA) only.

This symbol indicates that this product is not to be disposed of with your household waste, according to the WEEE Directive (2002/96/EC) and your national law. This product should be handed over to a designated collection point, e.g., on an authorized one-for-one basis when you buy a new similar product or to an authorized collection site for recycling waste electrical and electronic equipment (EEE). Improper handling of this type of waste could have a possible negative impact on the environment and human health due to potentially hazardous substances that are generally associated with EEE. At the same time, your cooperation in the correct disposal of this product will contribute to the effective usage of natural resources. For more information about where you can drop off your waste equipment for recycling, please contact your local city office, waste authority, approved WEEE scheme or your household waste disposal service. Your cooperation in the correct disposal of this product will contribute to the effective usage of natural resources and will avoid incurring administrative sanctions according to art. 50 and following of Italian legislative decree 22/97. For more information regarding return and recycling of WEEE products, please visit www.canon-europe.com/environment.

(EEA: Norway, Iceland and Liechtenstein)

Index

4 sec., 6 sec., 16 sec. timer12

A

AF-assist beam20
Auto external flash metering36
Auto power off16, 95
Auto zoom support for image sensor size20, 98
Av (aperture-priority AE)19

B

Batteries14
Beep99
Bounce27

C

C.Fn92, 95
Clear All46
Clearing Speedlite settings38, 43
Color filter39
Color filter holder11, 39, 104
Color temperature information transmission20
Custom functions (C.Fn)92, 95

D

Distance indicator display95

E

Effective flash range8, 18, 25, 36, 37
E-TTL II (flash metering)44
E-TTL II/E-TTL autoflash19
Ext.A (Auto external flash metering)36
Ext.M (Manual external flash metering)37
External power99, 105

F

FE lock24
FEB23
Firing group61, 62, 64, 65, 85, 86, 88
Flash control42
Flash coverage29
Flash exposure compensation22

Flash exposure confirmation lamp7, 18
Flash exposure level8, 22, 32
Flash firing restriction106
Flash frequency33
Flash function settings41
Flash metering mode96
Flash mode8, 9, 10, 43, 44
Flash operation range48, 76
Flash output31, 33, 64, 88
Flash positions48, 76
Flash ratio
 Three groups (A:B C)62, 86
 Two groups (A:B)61, 85
Flash recycling16
Flash sync. speed44
Flash sync. speed in Av mode44
Fully automatic flash shooting18
Function settings41

G

Guide No.115

H

High-speed sync25
Hot shoe2

I

INDIVIDUAL SLAVE10, 89
Individual slave89
ISO speed37

L

LCD panel8
 Density39, 101
 Illumination17, 100
 Illumination color101
Light distribution100
LINK7, 55, 58
Linked shooting10, 70
LOCK17
Lock function17

M

M (manual exposure)19
Manual external flash metering ...37
Manual flash31

- Master flash firing ON/OFF ... 55, 79
 Master unit setting 52, 78
 Maximum number of continuous
 flashes 35
 Memory function 56, 80
 Metered manual flash 32
 Modeling flash 38
 MULTI 33
- N**
- Normal flash 14
 Number of flashes 14
- O**
- Optical transmission wireless
 shooting 75
 Fully automatic one slave unit
 81
 Fully automatic three groups
 (A:B C) 86
 Fully automatic two groups (A:B)
 85
 Manual flash 88
- P**
- P (Program AE) 18
 P.Fn 92, 101
 Personal functions (P.Fn) ... 92, 101
- Q**
- Quick Flash 16
- R**
- Radio transmission wireless
 shooting 47
 Fully automatic one slave unit
 57
 Fully automatic three groups
 (A:B C) 62
 Fully automatic two groups (A:B)
 61
 Group firing 65
 Manual flash 64
 Recycling time 14
 Remote release 68
- S**
- Scan 54
- Second-curtain sync 26
 Short distance flash shooting 29
 Shutter speed 19
 Shutter sync. 44
 Slave group control 63, 87
 Slave unit 10, 47, 75
 Battery check 100
 Slave unit setting 52, 78
 Stroboscopic flash 33
- T**
- Temperature increase 106
 Test flash 16, 50, 58, 67, 82
 Transmission channel
 52, 53, 54, 78
 Transmitter 47, 75, 104
 TTL autoflash 116
 Tv (Shutter-priority AE) 19
 Type-A camera 2
 Type-B camera 116
- W**
- Warning icon 106
 Wide panel 30
 Wireless button 7, 52, 78, 102
 Wireless multiple flash shooting
 49, 77
 Wireless radio ID 52, 53
 Wireless settings 52, 78
- Z**
- Zoom 29
 Auto setting 29
 Manual setting 29

Canon

The cameras and accessories referred to in this Instructions booklet are current as of January 2012. For information on compatibility with the cameras and accessories marketed after this date, contact your nearest Canon Service Center.



CANON INC. 30-2, Shimomaruko 3-chome, Ohta-ku, Tokyo 146-8501, Japan

U.S.A. ————— **CANON U.S.A. INC.**

One Canon Plaza, Lake Success, NY 11042-1198, U.S.A.
For all inquires concerning this product, call toll free in the U.S.
1-800-OK-CANON

CANADA ————— **CANON CANADA INC. HEADQUARTERS**

6390 Dixie Road, Mississauga, Ontario L5T 1P7, Canada

CANON CANADA INC. MONTREAL BRANCH

5990, Côte-de-Liesse, Montréal Québec H4T 1V7, Canada

CANON CANADA INC. CALGARY OFFICE

2828, 16th Street, N.E. Calgary, Alberta T2E 7K7, Canada

For all inquiries concerning this product, call toll free in Canada

1-800-OK-CANON

EUROPE, ————— **CANON EUROPA N.V.**

AFRICA & Bovenkerkerweg 59-61, 1185 XB Amstelveen, The Netherlands

MIDDLE EAST **CANON FRANCE S.A.S.**

17, Quai du Président Paul Doumer, 92414 Courbevoie Cedex, France

CANON UK LTD.

Woodhatch Reigate, Surrey RH2 8BF, United Kingdom

CANON DEUTSCHLAND GmbH

Europark Fichtenhain A10, 47807 Krefeld, Germany

CANON ITALIA S.p.A.

Via Milano 8, 20097 San Donato Milanese, (MI), Italy

CANON Schweiz A.G.

Industriestrasse 12, 8305 Dietlikon, Switzerland

Canon GmbH

Zetschegasse 11, A-1230 Vienna, Austria

CANON España, S.A.

Av. De Europa, 6 Alcobendas 28108 Madrid, Spain

CANON Portugal S.A.

Rua Alfredo da Silva, 14 Alfragide 2610-016 Amadora, Portugal

CENTRAL & ————— **CANON LATIN AMERICA, INC.**

SOUTH AMERICA 703 Waterford Way, Suite 400 Miami, FL 33126, U.S.A.

ASIA ————— **CANON (China) Co., LTD.**

15F Jinbao Building No.89 Jinbao Street, Dongcheng District, Beijing 100005, China

CANON HONGKONG CO., LTD.

19/F., The Metropolis Tower, 10 Metropolis Drive, Hungghom, Kowloon, Hong Kong

CANON SINGAPORE PTE. LTD.

1 HarbourFront Avenue, #04-01 Keppel Bay Tower, Singapore 098632

CANON KOREA CONSUMER IMAGING INC.

Canon BS Tower 5F, #168-12 Samseong-dong, Gangnam-gu, Seoul, Korea

OCEANIA ————— **CANON AUSTRALIA PTY. LTD.**

1 Thomas Holt Drive, North Ryde, Sydney N.S.W. 2113, Australia

CANON NEW ZEALAND LTD.

Akoranga Business Park, Akoranga Drive, Northcote, Auckland, New Zealand

JAPAN ————— **CANON MARKETING JAPAN INC.**

16-6, Kohnan 2-chome, Minato-ku, Tokyo 108-8011, Japan

J 日本語

同じ場所に複数の電波通信ワイヤレス多灯システムを構築するときは、異なるチャンネルに設定していても混信することがあるため、チャンネルごとに異なる電波通信 ID を設定してください。(600EX-RT/600EX 使用説明書 : p.53、ST-E3-RT 使用説明書 : p.21)

電波通信ワイヤレスストロボ撮影時に、スレーブが発光しないときや意図せずにフル発光するときは、以下の対応を行ってください。

- チャンネルをスキャンして電波状態の良いチャンネルに設定する
(600EX-RT/600EX 使用説明書 : p.54、ST-E3-RT 使用説明書 : p.22)
- マスターからできるだけ見通しの良い場所にスレーブを設置する
- スレーブ本体の正面部分をマスターに向ける

E English

When establishing multiple radio transmission wireless flash systems, interference between flash systems may occur, even if the flashes are set to different channels. Set different radio transmission IDs for each channel.
(600EX-RT/600EX Instruction manual: p.53, ST-E3-RT Instruction manual: p.21)

If the slave unit does not fire or unexpectedly fires at full output when using radio transmission wireless flash shooting, perform any of the operations below.

- Run the channel scan and set the channel with the best radio reception signal.
(600EX-RT/600EX Instruction manual: p.54, ST-E3-RT Instruction manual: p.22)
- Position the slave unit in clear view of the master unit, without obstacles between them.
- Face the slave unit's front toward the master unit.

F Français

Lors de la mise en place de systèmes de flash multiple sans fil par transmission radio, des interférences entre les systèmes de flash peuvent avoir lieu, même si les flashes sont réglés sur des canaux différents. Réglez des ID de transmission radio différentes pour chaque canal.
(Mode d'emploi du 600EX-RT/600EX : p.53, mode d'emploi du ST-E3-RT : p.21)

Si le flash asservi ne se déclenche pas ou est émis subitement à pleine puissance lors de l'utilisation de la prise de vue avec flash sans fil par transmission radio, exécutez l'une des opérations ci-dessous.

- Procédez au balayage de canaux et réglez le canal avec le meilleur signal de réception radio.
(Mode d'emploi du 600EX-RT/600EX : p.54, mode d'emploi du ST-E3-RT : p.22)
- Placez le flash asservi dans une vue dégagée par rapport au flash maître, sans obstacle entre eux.
- Placez le devant du flash asservi en face du flash maître.

S Español

Al establecer varios sistemas de flash inalámbrico con transmisión por radio, se pueden producir interferencias entre sistemas de flash, aunque los flashes estén ajustados en diferentes canales. Ajuste un ID de transmisión por radio diferente para cada canal.
(Manual de instrucciones de 600EX-RT/600EX: p. 53, Manual de instrucciones de ST-E3-RT: p. 21)

Si la unidad secundaria no se dispara o se dispara inesperadamente a plena potencia cuando se utilice el disparo de flash inalámbrico mediante transmisión por radio, realice cualquiera de las operaciones siguientes.

- Ejecute la exploración de canales y ajuste el canal que tenga la mejor recepción de señal de radio.
(Manual de instrucciones de 600EX-RT/600EX: p. 54, Manual de instrucciones de ST-E3-RT: p. 22)
- Coloque la unidad secundaria claramente a la vista de la unidad principal sin obstáculos entre ellas.
- Oriente la parte frontal de la unidad secundaria hacia la unidad principal.

G Deutsch

Bei der Aufstellung mehrerer drahtloser Funk-Blitzsteuerungssysteme kann es zu Störungen zwischen den Blitzsystemen kommen, auch wenn die Blitzgeräte auf verschiedene Kanäle eingestellt sind. Stellen Sie für jeden Kanal eine eigene Geräteerkennung ein.
(Bedienungsanleitung 600EX-RT/600EX: S. 53, Bedienungsanleitung ST-E3-RT: S. 21)

Wenn die Slave-Einheit bei der drahtlosen Blitzsteuerung über Funk entweder gar nicht oder unerwartet mit voller Leistung auslöst, führen Sie eine der folgenden Aktionen aus.

- Führen Sie die Kanalsuche aus, und stellen Sie den Übertragungskanal mit dem besten Funkempfangssignal ein.
(Bedienungsanleitung 600EX-RT/600EX: S. 54, Bedienungsanleitung ST-E3-RT: S. 22)
- Stellen Sie die Slave-Einheit so auf, dass eine unverstellte Sicht zwischen Slave- und Master-Einheit besteht (ohne Hindernisse).
- Richten Sie die Vorderseite der Slave-Einheit auf die Master-Einheit aus.

I Italiano

Quando si configurano sistemi di flash multipli senza fili a trasmissione radio, è possibile che si verifichino interferenze tra i sistemi di flash, anche se i flash sono impostati su canali diversi. Impostare ID di trasmissione radio diversi per ciascun canale.
(Manuale d'uso 600EX-RT/600EX: p. 53, manuale d'uso ST-E3-RT: p. 21)

Se l'unità slave non scatta o scatta inaspettatamente a piena potenza durante lo scatto con flash senza fili a trasmissione radio, eseguire una delle seguenti operazioni.

- Eseguire la scansione dei canali e impostare il canale con la migliore ricezione del segnale radio.
(Manuale d'uso 600EX-RT/600EX: p. 54, manuale d'uso ST-E3-RT: p. 22)
- Posizionare l'unità slave in vista dell'unità master, senza ostacoli fra di esse.
- Puntare il lato anteriore dell'unità slave verso l'unità master.

D Nederlands

 Bij het opzetten van meerdere draadloze flitssystemen met radiotransmissie kan er interferentie optreden tussen de flitssystemen, zelfs als de flitsers zijn ingesteld op verschillende kanalen. Stel voor elk kanaal verschillende radiotransmissie-ID's in.
(Instructiehandleiding 600EX-RT/600EX: p. 53, Instructiehandleiding ST-E3-RT: p. 21)

 Voer een van de volgende handelingen uit als de slave-unit niet flitst of onverwacht met volledig vermogen flitst bij draadloze flitsfotografie met radiotransmissie:

- Voer de kanaalscan uit en stel het kanaal in waarop de radiosignalen het best worden ontvangen.
(Instructiehandleiding 600EX-RT/600EX: p. 54, Instructiehandleiding ST-E3-RT: p. 22)
- Plaats de slave-unit in direct zicht van de masterunit, zonder obstakels ertussen.
- Richt de voorkant van de slave-unit naar de masterunit.

R Русский

 В случае организации нескольких систем вспышек с радиоуправлением системы вспышек могут создавать взаимные помехи, даже если они используют разные каналы. Установите отличающиеся идентификаторы для каждого канала.
(Инструкция по эксплуатации 600EX-RT/600EX: стр. 53, Инструкция по эксплуатации ST-E3-RT: стр. 21)

 Если при съемке со вспышкой с радиоуправлением ведомое устройство не срабатывает или неожиданно срабатывает на полной мощности, выполните любое из описанных ниже действий.

- Запустите сканирование каналов и установите канал с наилучшим приемом радиосигналов.
(Инструкция по эксплуатации 600EX-RT/600EX: стр. 54, Инструкция по эксплуатации ST-E3-RT: стр. 22)
- Установите ведомое устройство в прямой видимости от ведущего устройства так, чтобы между устройствами не было препятствий.
- Направьте переднюю часть ведомого устройства на ведущее устройство.

sC 简体中文

 当建立无线电传输无线多重闪光系统时，即使闪光灯设为不同的频道，也可能发生闪光系统之间的干扰。为各频道设定不同的无线电传输ID。
(600EX-RT/600EX使用说明书：第53页，ST-E3-RT使用说明书：第21页)

 当使用无线电传输无线闪光拍摄时，如果从属单元不闪光或意外以全输出闪光，执行下列任何一个操作。

- 进行频道扫描并设定具有最佳无线电接收信号的频道。
(600EX-RT/600EX使用说明书：第54页，ST-E3-RT使用说明书：第22页)
- 摆放从属单元时保持其与主控单元之间视野清晰，没有障碍物。
- 将从属单元的前面朝向主控单元。

tC 繁體中文

 建立無線電傳送型無線多支閃燈系統時，即使將閃燈設定至不同的頻道，閃燈系統之間也可能會發生干擾。請為各頻道設定不同的無線電傳送ID。
(600EX-RT/600EX使用說明書：第53頁，ST-E3-RT使用說明書：第21頁)

 如果從屬單元在使用無線電傳送無線閃光拍攝時沒有閃光或者意外地以全輸出閃光，請執行下列操作中的任何一項。

- 執行頻道掃描，並以最好的無線電接收訊號設定頻道。
(600EX-RT/600EX使用說明書：第54頁，ST-E3-RT使用說明書：第22頁)
- 將從屬單元擺在可以清楚看到主控單元的地方，彼此之間不要有障礙。
- 將從屬單元的正面對著主控單元。

CANON INC.

30-2, Shimomaruko 3-chome, Ohta-ku, Tokyo 146-8501, Japan

CANON EUROPA N.V.

Bovenkerkerweg 59-61, 1185 XB Amstelveen, The Netherlands

CIY-M004-000
2012.01

© CANON INC. 2012

PRINTED IN JAPAN
IMPRIMÉ AU JAPON
IMPRESO EN JAPÓN

J 日本語

- ⚠ 電源スイッチを入れたときや電池を入れたときに、初期化動作により、カラーフィルターセンサー（LED）が一瞬点灯することがあります。

E English

- ⚠ When you turn on the flash or install the batteries, the flash may reset and the color filter sensor (LED) may flash briefly.

F Français

- ⚠ Lorsque vous allumez le flash ou installez les piles, il se peut que le flash se réinitialise et que le capteur du filtre couleur (LED) clignote brièvement.

S Español

- ⚠ Cuando encienda el flash o instale las pilas, es posible que el flash se reinicie y el sensor del filtro color (LED) parpadee brevemente.

G Deutsch

- ⚠ Wenn Sie den Blitz einschalten oder die Batterien einlegen, kann es vorkommen, dass der Blitz zurückgesetzt wird und die Farbfiltersensor-LED kurz blinkt.

I Italiano

- ⚠ Quando si accende il flash o si installano le batterie, il flash potrebbe ripristinarsi e il sensore filtro colorato (LED) potrebbe lampeggiare brevemente.

D Nederlands

- ⚠ Wanneer u de flitser inschakelt of de batterijen plaatst, kan de flitser worden gereset en kan de kleurfiltersensor (LED) kort flitsen.

R Русский

- ⚠ При включении вспышки или установке элементов питания может произойти сброс вспышки и может кратковременно загореться датчик цветного фильтра (светодиод).

sc 简体中文

- ⚠ 当打开闪光灯或安装电池时，闪光灯可能会重设，并且色彩滤镜感应器（LED）可能会短暂地闪烁。

tc 繁體中文

- ⚠ 開啓閃光燈或安裝電池時，閃光燈可能會重設，而且顏色濾鏡感應器（LED）可能會短暫地閃光。

CANON INC.

30-2, Shimomaruko 3-chome, Ohta-ku, Tokyo
146-8501, Japan

CIZ-M004-000
2012.02

CANON EUROPA N.V.

Bovenkerkerweg 59-61, 1185 XB Amstelveen,
The Netherlands

© CANON INC. 2012

PRINTED IN JAPAN
IMPRIMÉ AU JAPON
IMPRESO EN JAPÓN

J 日本語

■ 600EX-RT/600EX使用説明書：51ページ

誤： EOS-1Ds、EOS-1D、EOS-1V、EOS 55、EOS Kiss III L、EOS Kiss III、New EOS Kiss、EOS IX E、EOS IX 50

正： EOS-1Ds、EOS-1D、EOS-1V、**EOS-3**、EOS 55、EOS Kiss III L、EOS Kiss III、New EOS Kiss、EOS IX E、EOS IX 50

E English

■ 600EX-RT/600EX INSTRUCTION MANUAL: Page 51

Error: EOS-1Ds, EOS-1D, EOS-1V, EOS ELAN II(E)/EOS 50(E), EOS REBEL 2000/EOS 300, EOS REBEL G/EOS 500N, EOS 66/EOS Rebel XS N/EOS 3000 N, EOS IX(E), EOS IX Lite/EOS IX 7

Correct: EOS-1Ds, EOS-1D, EOS-1V, **EOS-3**, EOS ELAN II(E)/EOS 50(E), EOS REBEL 2000/EOS 300, EOS REBEL G/EOS 500N, EOS 66/EOS Rebel XS N/EOS 3000 N, EOS IX(E), EOS IX Lite/EOS IX 7

F Français

■ 600EX-RT/600EX MODE D'EMPLOI : Page 51

Erreur : EOS-1Ds, EOS-1D, EOS-1V, EOS ELAN II(E)/EOS 50(E), EOS REBEL 2000/EOS 300, EOS REBEL G/EOS 500N, EOS 66/EOS Rebel XS N/EOS 3000 N, EOS IX(E), EOS IX Lite/EOS IX 7

Correct : EOS-1Ds, EOS-1D, EOS-1V, **EOS-3**, EOS ELAN II(E)/EOS 50(E), EOS REBEL 2000/EOS 300, EOS REBEL G/EOS 500N, EOS 66/EOS Rebel XS N/EOS 3000 N, EOS IX(E), EOS IX Lite/EOS IX 7

S Español

■ 600EX-RT/600EX MANUAL DE INSTRUCCIONES: Página 51

Error: EOS-1Ds, EOS-1D, EOS-1V, EOS ELAN II(E)/EOS 50(E), EOS REBEL 2000/EOS 300, EOS REBEL G/EOS 500N, EOS 66/EOS Rebel XS N/EOS 3000 N, EOS IX(E), EOS IX Lite/EOS IX 7

Correcto: EOS-1Ds, EOS-1D, EOS-1V, **EOS-3**, EOS ELAN II(E)/EOS 50(E), EOS REBEL 2000/EOS 300, EOS REBEL G/EOS 500N, EOS 66/EOS Rebel XS N/EOS 3000 N, EOS IX(E), EOS IX Lite/EOS IX 7

G Deutsch

■ 600EX-RT/600EX BEDIENUNGSANLEITUNG: Seite 51

Falsch: EOS-1Ds, EOS-1D, EOS-1V, EOS ELAN II(E)/EOS 50(E), EOS REBEL 2000/EOS 300, EOS REBEL G/EOS 500N, EOS 66/EOS Rebel XS N/EOS 3000 N, EOS IX(E), EOS IX Lite/EOS IX 7

Richtig: EOS-1Ds, EOS-1D, EOS-1V, **EOS-3**, EOS ELAN II(E)/EOS 50(E), EOS REBEL 2000/EOS 300, EOS REBEL G/EOS 500N, EOS 66/EOS Rebel XS N/EOS 3000 N, EOS IX(E), EOS IX Lite/EOS IX 7

I Italiano

■ 600EX-RT/600EX MANUALE D'USO: Pagina 51

Errato: EOS-1Ds, EOS-1D, EOS-1V, EOS ELAN II(E)/EOS 50(E), EOS REBEL 2000/EOS 300, EOS REBEL G/EOS 500N, EOS 66/EOS Rebel XS N/EOS 3000 N, EOS IX(E), EOS IX Lite/EOS IX 7

Corretto: EOS-1Ds, EOS-1D, EOS-1V, **EOS-3**, EOS ELAN II(E)/EOS 50(E), EOS REBEL 2000/EOS 300, EOS REBEL G/EOS 500N, EOS 66/EOS Rebel XS N/EOS 3000 N, EOS IX(E), EOS IX Lite/EOS IX 7

600EX-RT/600EX INSTRUCTIEHANDLEIDING: Pagina 51

- Fout: EOS-1Ds, EOS-1D, EOS-1V, EOS ELAN II(E)/EOS 50(E), EOS REBEL 2000/EOS 300, EOS REBEL G/EOS 500N, EOS 66/EOS Rebel XS N/EOS 3000 N, EOS IX(E), EOS IX Lite/EOS IX 7
- Correct: EOS-1Ds, EOS-1D, EOS-1V, **EOS-3**, EOS ELAN II(E)/EOS 50(E), EOS REBEL 2000/EOS 300, EOS REBEL G/EOS 500N, EOS 66/EOS Rebel XS N/EOS 3000 N, EOS IX(E), EOS IX Lite/EOS IX 7

600EX-RT/600EX ИНСТРУКЦИЯ ПО ЭКСПЛУАТАЦИИ: стр. 51

- Ошибка: EOS-1Ds, EOS-1D, EOS-1V, EOS ELAN II(E)/EOS 50(E), EOS REBEL 2000/EOS 300, EOS REBEL G/EOS 500N, EOS 66/EOS Rebel XS N/EOS 3000 N, EOS IX(E), EOS IX Lite/EOS IX 7
- Правильно: EOS-1Ds, EOS-1D, EOS-1V, **EOS-3**, EOS ELAN II(E)/EOS 50(E), EOS REBEL 2000/EOS 300, EOS REBEL G/EOS 500N, EOS 66/EOS Rebel XS N/EOS 3000 N, EOS IX(E), EOS IX Lite/EOS IX 7

600EX-RT/600EX 使用说明书: 第51页

- 错误: EOS-1Ds, EOS-1D, EOS-1V, EOS ELAN II(E)/EOS 50(E), EOS REBEL 2000/EOS 300, EOS REBEL G/EOS 500N, EOS 66/EOS Rebel XS N/EOS 3000 N, EOS IX(E), EOS IX Lite/EOS IX 7
- 正确: EOS-1Ds, EOS-1D, EOS-1V, **EOS-3**, EOS ELAN II(E)/EOS 50(E), EOS REBEL 2000/EOS 300, EOS REBEL G/EOS 500N, EOS 66/EOS Rebel XS N/EOS 3000 N, EOS IX(E), EOS IX Lite/EOS IX 7

600EX-RT/600EX 使用說明書: 第51頁

- 錯誤: EOS-1Ds, EOS-1D, EOS-1V, EOS ELAN II(E)/EOS 50(E), EOS REBEL 2000/EOS 300, EOS REBEL G/EOS 500N, EOS 66/EOS Rebel XS N/EOS 3000 N, EOS IX(E), EOS IX Lite/EOS IX 7
- 正確: EOS-1Ds, EOS-1D, EOS-1V, **EOS-3**, EOS ELAN II(E)/EOS 50(E), EOS REBEL 2000/EOS 300, EOS REBEL G/EOS 500N, EOS 66/EOS Rebel XS N/EOS 3000 N, EOS IX(E), EOS IX Lite/EOS IX 7

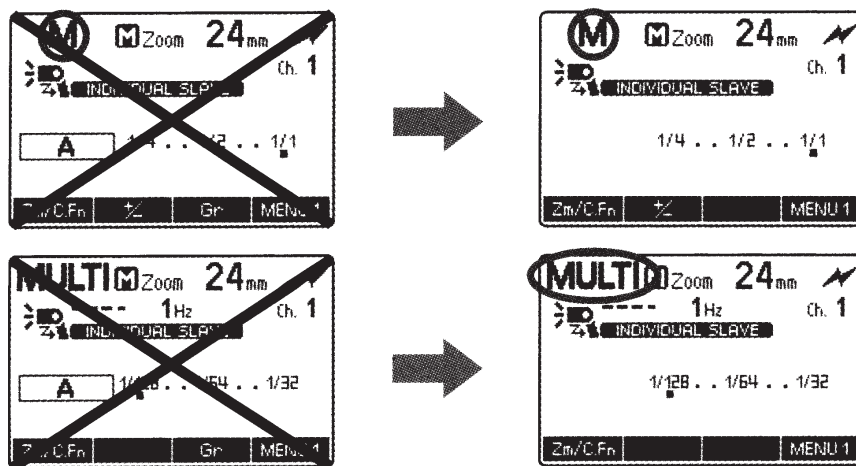
89ページ/Page 89/Page 89/Página 89/Seite 89/Pagina 89/Pagina 89/стр. 89/第89页/第89頁**CANON INC.**

30-2, Shimomaruko 3-chome, Ohta-ku, Tokyo
146-8501, Japan

CIP-M004-000
2012.01

CANON EUROPA N.V.

Bovenkerkerweg 59-61, 1185 XB Amstelveen,
The Netherlands

© CANON INC. 2012

PRINTED IN JAPAN
IMPRIMÉ AU JAPON
IMPRESO EN JAPÓN

■ Regions of Use and Restrictions for the 600EX-RT/ST-E3-RT

- The Speedlite 600EX-RT/ST-E3-RT complies with local radio wave regulations in the following areas. Please do not use this product in areas it was not designed for.

Brunei, Sri Lanka, China, Taiwan, Hong Kong, India, Japan, Macao, Philippines, Singapore, Vietnam, Canada, United States, Cayman Islands, Colombia, Costa Rica, Ecuador, El Salvador, Guatemala, Panama, Peru, Austria, Belgium, Bulgaria, Cyprus, Czech Republic, Denmark, Estonia, Finland, France, Germany, Greece, Hungary, Iceland, Ireland, Italy, Latvia, Liechtenstein, Lithuania, Luxembourg, Malta, the Netherlands, Norway, Poland, Portugal, Romania, Russia, Slovakia, Slovenia, Spain, Sweden, Switzerland, United Kingdom, Australia, New Zealand, Lebanon, Saudi Arabia, Turkey

- The following actions may be punishable under law. Disassembling or modifying the transmitter, or removing the certification label on it.
- Do not use the transmitter near other devices that emit radio waves, such as medical equipment or electronic devices. The transmitter may interfere with operation of these devices.

Complies with
IDA Standards
DB00671

FCC/IC NOTICE

This device complies with Part 15 of the FCC Rules and RSS-Gen of IC Rules.

Operation is subject to the following two conditions;

- (1) this device may not cause harmful interference, and
- (2) this device must accept any interference received, including interference that may cause undesired operation of this device.

Note: This equipment has been tested and found to comply with the limits for class B digital device, pursuant to Part 15 of the FCC Rules.

These limits are designed to provide reasonable protection against harmful interference in a residential installation. This equipment generates, uses and can radiate radio frequency energy and, if not installed and used in accordance with the instructions, may cause harmful interference to radio communications. However, there is no guarantee that interference will not occur in a particular installation. If this equipment does cause harmful interference to radio or television reception, which can be determined by turning the equipment off and on, the user is encouraged to try to correct the interference by one or more of the following measures:

- Reorient or relocate the receiving antenna.
- Increase the separation between the equipment and receiver.
- Connect the equipment into an outlet on a circuit different from that to which the receiver is connected.
- Consult the dealer or an experienced radio/TV technician for help.

This transmitter must not be co-located or operated in conjunction with any other antenna or transmitter except Canon accessories supplied or designated for this product.

Do not make any changes or modifications to the equipment unless otherwise specified in the manual. If such changes or modifications should be made, you could be required to stop operation of the equipment.

This equipment complies with FCC/IC radiation exposure limits set forth for an uncontrolled environment and meets the FCC radio frequency (RF) Exposure Guidelines in Supplement C to OET65 and RSS-102 of the IC radio frequency (RF) Exposure rules. This equipment has very low levels of RF energy that are deemed to comply without testing of specific absorption ratio (SAR).

Canadian Radio Interference Regulations

The Class B digital apparatus complies with Canadian ICES-003.

**Canon® EOS Digital Camera™ and Accessories Limited Warranty –
For U.S.A. & Canada Only**

The limited warranty set forth below is given by Canon U.S.A., Inc. (Canon U.S.A.) in the United States or Canon Canada Inc. (Canon Canada) in Canada with respect to the Canon brand EOS Digital Camera, as well as with respect to the accessories packaged with this limited warranty (collectively the "Products"), when purchased and used in the United States or Canada. The Products are the only Products to which this limited warranty applies.

Your Products, when delivered to you in new condition in its original container, are warranted against defects in materials or workmanship as follows: for a period of one (1) year from the date of original purchase, defective parts or defective Products returned to Canon U.S.A. or Canon Canada, or their authorized Products service providers, as applicable, and proven to be defective upon inspection, will be repaired with new or comparable rebuilt parts or exchanged for refurbished Products, as determined by Canon U.S.A. or Canon Canada, or the authorized Products service provider.

THIS WARRANTY DOES NOT COVER ANY ACCESSORIES NOT MENTIONED ABOVE. This limited warranty shall only apply if the Products are used in conjunction with compatible computer equipment and compatible software, as to which items Canon U.S.A. or Canon Canada shall have no responsibility.

Non-Canon brand equipment and software that may be distributed with the Products are sold "as is" and without warranty of any kind by Canon U.S.A. or Canon Canada, including any implied warranty regarding merchantability or fitness for a particular purpose, and all such warranties are disclaimed. The sole warranty, if any, with the respect to such non-Canon brand items is given by the manufacturer or producer thereof.

This limited warranty covers all defects encountered in normal use of the Products, and does not apply in the following cases:

- (a) Loss of or damage to the Products due to abuse, mishandling, improper packaging by you, alteration, accident, electrical current fluctuations, failure to follow operating, maintenance or environmental instructions prescribed in Canon U.S.A.'s or Canon Canada's user's manual or services performed by someone other than Canon U.S.A. or Canon Canada, or an authorized Products service provider. Without limiting the foregoing, water damage, sand/corrosion damage, battery leakage, dropping the camera, scratches, abrasions or damage to the body, lenses or LCD display or damage to any of the Accessories mentioned in the first paragraph above will be presumed to have resulted from misuse, abuse or failure to operate the Products as set forth in the operating instructions.
- (b) Use of parts or supplies (other than those sold by Canon U.S.A. or Canon Canada) that cause damage to the Products or cause abnormally frequent service calls or service problems.
- (c) If the Products had had their serial number or dating altered or removed.

NO IMPLIED WARRANTY, INCLUDING ANY IMPLIED WARRANTY OF MERCHANTABILITY OR FITNESS FOR A PARTICULAR PURPOSE, APPLIES TO THE PRODUCTS AFTER THE APPLICABLE PERIOD OF THE EXPRESS LIMITED WARRANTY STATED ABOVE, AND NO OTHER EXPRESS WARRANTY OR GUARANTY, EXCEPT AS MENTIONED ABOVE, GIVEN BY ANY PERSON OR ENTITY WITH RESPECT TO THE PRODUCTS SHALL BIND CANON U.S.A. OR CANON CANADA. (SOME STATES AND PROVINCES DO NOT ALLOW LIMITATIONS ON HOW LONG AN IMPLIED WARRANTY LASTS, SO THE ABOVE LIMITATION MAY NOT APPLY TO YOU.) CANON U.S.A. OR CANON CANADA SHALL NOT BE LIABLE FOR LOSS OF REVENUES OR PROFITS, INCONVENIENCE, EXPENSE FOR SUBSTITUTE EQUIPMENT OR SERVICE, STORAGE CHARGES, LOSS OR CORRUPTION OF DATA, OR ANY OTHER SPECIAL, INCIDENTAL OR CONSEQUENTIAL DAMAGES CAUSED BY THE USE OR MISUSE OF, OR INABILITY TO USE, THE PRODUCTS, REGARDLESS OF THE LEGAL THEORY ON WHICH THE CLAIM IS BASED, AND EVEN IF CANON U.S.A. OR CANON CANADA HAS BEEN ADVISED OF THE POSSIBILITY OF SUCH DAMAGES. IN NO EVENT SHALL RECOVERY OF ANY KIND AGAINST CANON U.S.A. OR CANON CANADA BE GREATER IN AMOUNT THAN THE PURCHASE PRICE OF THE PRODUCTS SOLD BY CANON U.S.A. OR CANON CANADA AND CAUSING THE ALLEGED DAMAGE. WITHOUT LIMITING THE FOREGOING, YOU ASSUME ALL RISK AND LIABILITY FOR LOSS, DAMAGE OR INJURY TO YOU AND YOUR PROPERTY AND TO OTHERS AND THEIR PROPERTY ARISING OUT OF USE OR MISUSE OF, OR INABILITY TO USE, THE PRODUCTS NOT CAUSED DIRECTLY BY THE NEGLIGENCE OF CANON U.S.A. OR CANON CANADA. (SOME STATES AND PROVINCES DO NOT ALLOW THE EXCLUSION OR LIMITATION OF INCIDENTAL OR CONSEQUENTIAL DAMAGES, SO THE ABOVE EXCLUSION OR LIMITATION MAY NOT APPLY TO YOU.) THIS LIMITED WARRANTY SHALL NOT EXTEND TO ANYONE OTHER THAN THE ORIGINAL PURCHASER OF THE PRODUCTS, OR THE PERSON FOR WHOM IT WAS PURCHASED AS A GIFT, AND STATES YOUR EXCLUSIVE REMEDY.

Canon U.S.A.

You may obtain technical support for your Products as follows:

- Internet support at www.usa.canon.com/support (E-mail support also available)
- Telephone assistance from a Canon U.S.A. Customer Care representative free of charge during regular business hours at **1-800-OK-CANON (1-800-652-2666)**.

Canon Canada

You may obtain technical support for your Products as follows:

- Internet support for English at www.canon.ca/english/ics (E-mail support also available)
- Internet support for French at www.canon.ca/francaise/ics (E-mail support also available)
- Telephone assistance from a Canon Canada Customer Care representative free of charge during regular business hours at **1-800-OK-CANON (1-800-652-2666)**.

When you call, have your Products serial numbers and your date of purchase available to expedite service. A Canon Customer Care representative will attempt to diagnose the nature of the problem and correct it over the telephone. If the problem cannot be corrected over the telephone, you will be asked to follow the applicable procedures for MAIL-IN SERVICE. Note that a dated proof of purchase is required at the time of service. This requirement will be satisfied by providing a copy of your dated bill of sale.

Technical support program terms are subject to change without notice.

MAIL-IN SERVICE

MAIL-IN SERVICE is a program under which your Products are repaired by a Canon U.S.A. or a Canon Canada authorized Products service provider. You will be given the name, address and phone number of an authorized Products service provider, by contacting 1-800-OK-CANON (1-800-652-2666) (Canon U.S.A. Customer Care representative / Canon Canada Customer Care representative). It is your responsibility to properly package and send the defective Products, together with a copy of your dated proof of purchase, a complete explanation of the problem and a return address to the authorized Products service provider at your expense. Do not include any other items with the defective Products. The defective Products covered by this limited warranty will be repaired and returned to you without charge by the authorized Products service provider. Any Products received by the authorized Products service provider that are not covered by the limited warranty will be returned unrepaired, or at the discretion of the authorized Products service provider, you may receive a written estimate of repair at such cost as the service provider may establish from time to time.

This limited warranty gives you specific legal rights, and you may also have other rights, which vary from state to state (or province to province in Canada).

*The battery pack packaged with the Products carries a separate ninety (90) day limited warranty.

**Canon U.S.A., Inc.
Canon Canada, Inc.**

© 2000 Canon U.S.A., Inc. Canon is a registered trademark and EOS is a trademark of Canon Inc.
All brand or product names are registered trademarks or trademarks of their respective owners.

| | | | | | | | | |
|--|--|--------------------------------------|-----------------|--------------------|------------------------|--|-------------------------------|-----|
| CANON LIMITED WARRANTY | | | | | | | | |
| CANON U.S.A., INC. CANON CANADA INC. | | | | | | | | |
| NAME NOM | | | | | | | | |
| ADDRESS ADRESSE | | | | | | | | |
| CITY VILLE | PROVINCE | POSTAL CODE CODE POSTAL | | | | | | |
| <p>THESE ARE NOT REGISTRATION CARDS – Retain for your Records</p> <p>CES CARTES NE SONT PAS CELLES POUR L'ENREGISTREMENT. – Les conserver comme référence.</p> | | | | | | | | |
| DEALER'S NAME & ADDRESS MARCHAND NOM & ADRESSE | <table border="1" style="width: 100%; border-collapse: collapse;"> <tr> <td style="width: 30%;">MODEL MODELE</td> <td style="width: 70%;">SPEEDLITE 600EX-RT</td> </tr> <tr> <td>BODY NO. BOITIER NO</td> <td></td> </tr> <tr> <td>PURCHASE DATE DATE D'ACHAT</td> <td>/ /</td> </tr> </table> | | MODEL MODELE | SPEEDLITE 600EX-RT | BODY NO. BOITIER NO | | PURCHASE DATE DATE D'ACHAT | / / |
| MODEL MODELE | SPEEDLITE 600EX-RT | | | | | | | |
| BODY NO. BOITIER NO | | | | | | | | |
| PURCHASE DATE DATE D'ACHAT | / / | | | | | | | |
| CT5-7163-004 0000Ni0.0 | USA CT5-7163 | Printed in JAPAN Imprimé au JAPON | | | | | | |

**Dealer Record of Canon Purchase
Fiche d'Achat pour Concessionnaire Canon**

**Complete this card at time of sale.
A remplir au moment de l'achat**

| | | | |
|---|------------------------|--------------------------------|---|
| PRESENT OWNERSHIP AND PRODUCTS INTERESTED IN Articles déjà en possession ou juges dignes d'intérêt | | OWNS En possession | INTERESTED IN Intéressé par |
| CAMERAS APPAREILS -PHOTO | (Camera) (Appareil) | (Lens) (Objectif) | • • |
| | (Camera) (Appareil) | (Lens) (Objectif) | • • |
| INTERCHANGEABLE LENS Objectif interchangeable | OWNS En possession | INTERESTED IN Intéressé par | OTHER ACCESSORIES Autres accessoires |
| | OWNS En possession | INTERESTED IN Intéressé par | OTHER ACCESSORIES Autres accessoires |

| | | | |
|-----------------|--------------------|----------------------------|--|
| MODEL Modèle | SPEEDLITE 600EX-RT | SERIAL NO. No. de série | |
|-----------------|--------------------|----------------------------|--|

CUSTOMER
Client

| | |
|------------------------------|--------------------|
| NAME Nom | ADDRESS Adresse |
| CITY/STATE Ville/Province | ZIP Code postal |
| | PHONE Téléphone |

La présente garantie limitée est fournie par Canon U.S.A., Inc. (Canon U.S.A.) aux États-Unis ou Canon Canada Inc. (Canon Canada) au Canada à l'égard de l'appareil photo numérique EOS de marque Canon, des accessoires livrés avec cette garantie limitée (collectivement les « produits »), lorsqu'ils sont achetés et utilisés aux États-Unis ou au Canada. Les produits sont les seuls auxquels cette garantie limitée s'applique.

Tout produit, livré à l'état neuf dans son emballage d'origine, est garanti contre tout vice de matière et de fabrication comme suit : pendant une période de un (1) an à compter de la date de l'achat initial, les pièces ou les produits défectueux qui seront retournés à Canon U.S.A. ou Canon Canada, ou à leurs fournisseurs de service agréés de produits, selon le cas, et dont l'inspection confirme un défaut seront réparés avec de nouvelles pièces ou des pièces remises à neuf comparables, ou échangés contre des produits remis à neuf, tel que déterminé par Canon U.S.A. ou Canon Canada, ou le fournisseur de service agréé de produits.

CETTE GARANTIE NE COUVRE PAS LES ACCESSOIRES QUI NE SONT PAS MENTIONNÉS CI-DESSUS. La présente garantie limitée s'applique seulement si les produits sont utilisés conjointement avec un équipement informatique compatible et des logiciels compatibles, pour lesquels Canon U.S.A. ou Canon Canada n'assume aucune responsabilité.

L'équipement et les logiciels de marques autres que Canon qui peuvent être distribués avec les produits sont vendus « tels quels », sans garantie d'aucune sorte par Canon U.S.A. ou Canon Canada, y compris toute garantie implicite à l'égard de la qualité marchande ou de l'aptitude à une fin particulière. La seule garantie, si garantie il y a, liée à un article d'une marque autre que Canon, est donnée par le fabricant ou le producteur de cet article.

La présente garantie limitée couvre toutes les déficiences constatées pendant l'utilisation normale du produit, et ne s'applique pas aux cas suivants :

- La perte ou l'endommagement des produits causés par l'usage abusif, la manipulation négligente, l'emballage inadéquat fait par vous, les modifications, les accidents, les variations de courant électrique, l'omission d'observer les directives à l'égard du mode d'utilisation, des conditions d'entretien et du milieu ambiant énoncées dans le manuel d'utilisation de Canon U.S.A. ou Canon Canada, ou de l'entretien effectué ailleurs que chez Canon U.S.A. ou Canon Canada, ou un fournisseur de service agréé de produits. Sans vous limiter à ce qui précède, les dommages causés par l'eau, le sable et/ou la corrosion, les fuites de pile, la chute de l'appareil, les égratignures, l'abrasion ou les dommages au boîtier, aux objectifs, à l'affleureur à cristaux liquides ou les dommages causés à chacun des accessoires mentionnés au premier paragraphe ci-dessus, dommages que l'on présume découler de l'usage impropre, de l'usage abusif ou de l'impossibilité d'utiliser les produits, tel qu'indiqué dans les directives de fonctionnement ;
- L'utilisation de pièces ou de fournitures (autres que celles vendues par Canon U.S.A. ou Canon Canada) ayant pour effet d'endommager les produits ou d'entraîner une fréquence anormale d'appels d'entretien ou de problèmes nécessitant le recours au service d'entretien et après-vente ;
- La modification ou le retrait du numéro de série ou de datation des produits.

AUCUNE GARANTIE IMPLICITE, Y COMPRIS TOUTE GARANTIE IMPLICITE À L'ÉGARD DE LA QUALITÉ MARCHANDE OU DE L'APTITUDE À UNE FIN PARTICULIÈRE, NE S'APPLIQUE AUX PRODUITS APRÈS LA PÉRIODE PRÉSCRITE DE LA GARANTIE EXPRESSE LIMITÉE SUSMENTIONNÉE ET, À L'EXCEPTION DE LADITE GARANTIE EXPRESSE LIMITÉE, AUCUNE AUTRE GARANTIE EXPRESSE NI AUCUNE AUTRE GARANTIE ACCORDÉE PAR TOUTE PERSONNE OU ENTITÉ À L'ÉGARD DES PRODUITS N'AURA POUR EFFET DE LIER CANON U.S.A. OU CANON CANADA À TOUTE OBLIGATION, QUELLE QUELLE SOIT, (CERTAINS ÉTATS ET CERTAINES PROVINCES N'AUTORISENT AUCUNE RESTRICTION SUR LA DURÉE D'UNE GARANTIE IMPLICITE ; AINSI, IL EST POSSIBLE QUE LA RESTRICTION ÉNONCÉE CI-DESSUS NE S'APPLIQUE PAS DANS VOTRE CAS.) CANON U.S.A. OU CANON CANADA N'ASSUME AUCUNE RESPONSABILITÉ À L'ÉGARD DE LA PERTE DE PRODUITS D'EXPLOITATION OU DE PROFITS, NI À L'ÉGARD DES INCONVÉNIENTS ET DES FRAIS ENGAGÉS POUR LE REMPLACEMENT, L'ENTRETIEN, LES SERVICES D'ENTRETIEN ET APRÈS-VENTE, POUR L'ENTREPOSAGE, LA PERTE OU LA CORRUPTION DE DONNÉES, NI À L'ÉGARD DE TOUT DOMMAGE SPÉCIAL, INDIRECT OU ACCESSOIRE DÉCOULANT DE L'USAGE OU DE L'USAGE IMPROPRE, OU DE L'IMPOSSIBILITÉ D'UTILISER LES PRODUITS, QUELLE QUE SOIT L'ARGUMENTATION JURIDIQUE SUR LAQUELLE S'APPLIQUE LA DEMANDE, ET MÊME SI CANON U.S.A. OU CANON CANADA A ÉTÉ INFORMÉE DE LA POSSIBILITÉ DE TELS DOMMAGES, AUCUN RECOURS, QUELLE QU'EN SOIT LA FORME, CONTRE CANON U.S.A. OU CANON CANADA NE SÉRA SUPÉRIEUR AU MONTANT DU PRIX D'ACHAT DES PRODUITS VENDUS PAR CANON U.S.A. OU CANON CANADA ET À L'ORIGINE DES DOMMAGES PRÉSUMÉS, SANS VOUS LIMITER À CE QUI PRÉCÈDE. VOUS ASSUMEZ TOUTES LES RISQUES ET TOUTE LA RESPONSABILITÉ À L'ÉGARD DES PERTES, DES DOMMAGES MATÉRIELS ET DES BLESSURES CORPORELLES SUBIS PAR VOUS, VOTRE PROPRIÉTÉ OU D'AUTRES PERSONNES OU LEUR PROPRIÉTÉ EN RAISON DE L'USAGE, DE L'USAGE IMPROPRE, OU DE L'IMPOSSIBILITÉ D'UTILISER LES PRODUITS À MOINS QUE LESDITS DOMMAGES MATÉRIELS, PERTES ET BLESSURES CORPORELLES N'AIENT ÉTÉ CAUSÉS PAR LA NÉGLIGENCE DE CANON U.S.A. OU CANON CANADA. (CERTAINS ÉTATS ET CERTAINES PROVINCES N'AUTORISENT AUCUNE EXCLUSION NI RESTRICTION DES DOMMAGES ACCESSOIRES OU INDIRECTS ; AINSI, IL EST POSSIBLE QUE LA RESTRICTION OU L'EXCLUSION ÉNONCÉE CI-DESSUS NE S'APPLIQUE PAS DANS VOTRE CAS.) LA PRÉSENTE GARANTIE LIMITÉE N'EST PAS ACCORDÉE À D'AUTRES PERSONNES QUE L'ACHETEUR INITIAL DE TOUT PRODUIT, OU LA PERSONNE QUI A REÇU LESDITS PRODUITS EN CADEAU, ET CONSTITUE VOTRE RECOURS EXCLUSIF.

Canon U.S.A.

Des services de soutien technique pour vos produits sont offerts comme suit :

- Soutien Internet au moyen du site Web : www.usa.canon.com/support (Soutien par courrier électronique aussi disponible)
- Soutien téléphonique auprès d'un représentant du Centre de renseignements clientèle de Canon U.S.A., sans frais, pendant les heures normales d'ouverture au **1-800-OK-CANON (1-800-652-2666)**

Canon Canada

Des services de soutien technique pour vos produits sont offerts comme suit :

- Soutien Internet en anglais au moyen du site Web : www.canon.ca/english/cs (Soutien par courrier électronique aussi disponible)
- Soutien Internet en français au moyen du site Web : www.canon.ca/francais/cs (Soutien par courrier électronique aussi disponible)
- Soutien téléphonique auprès d'une représentante ou d'un représentant du Centre de renseignements clientèle de Canon Canada, sans frais, pendant les heures normales d'ouverture au **1-800-OK-CANON (1-800-652-2666)**

Lors de l'appel, assurez-vous d'avoir le numéro de série des produits et la date de son achat à portée de la main afin d'accélérer le service. Une représentante ou un représentant du Centre de renseignements clientèle de Canon tentera de déterminer la source du problème et de résoudre celui-ci par téléphone. S'il est impossible de résoudre le problème par téléphone, on vous priera de suivre les directives appropriées pour le SERVICE POSTAL. Veuillez noter qu'une preuve d'achat datée est requise lors du service d'entretien et après-vente. Il suffit de fournir une copie de votre acte de vente daté.

Les conditions du programme de soutien technique sont modifiables sans préavis.

SERVICE POSTAL

Le SERVICE POSTAL est un programme selon lequel les réparations de vos produits sont effectuées par un fournisseur de service agréé des produits de Canon U.S.A. ou Canon Canada. Vous obtiendrez le nom, l'adresse et le numéro de téléphone d'un fournisseur de service agréé des produits, en communiquant avec **1-800-OK-CANON (1-800-652-2666)** (représentant de service clientèle Canon U.S.A./représentant de service clientèle Canon Canada). Il vous incombe d'emballer adéquatement vos produits défectueux et de le faire parvenir, à vos frais, accompagné d'une copie de votre preuve d'achat datée, d'une explication détaillée du problème et de l'adresse de retour au fournisseur de service agréé des produits. Vous ne devez inclure aucun autre article avec les produits défectueux. Les produits couverts par la présente garantie limitée seront réparés et vous seront retournés sans frais par le fournisseur de service agréé de produits. Les produits non couverts par la présente garantie limitée reçus par le fournisseur de service agréé de produits seront retournés sans avoir été réparés ou, à la discrétion du fournisseur de service agréé de produits, vous pourrez recevoir une estimation écrite des frais de réparation au coût tel qu'il est établi à l'occasion par le fournisseur de service.

La présente garantie limitée vous accorde des droits particuliers reconnus par la loi et il se peut que vous disposiez d'autres droits qui peuvent varier d'un Etat à un autre (ou d'une province à une autre au Canada).

* Le bloc-batterie livré avec les produits comporte une garantie limitée séparée d'une durée de quatre-vingt-dix (90) jours.

**Canon U.S.A., Inc.
Canon Canada Inc.**

© Canon U.S.A., Inc., 2008. Canon est une marque déposée et EOS est une marque de commerce de Canon Inc.
Tous les autres noms de marques ou de produits sont des marques déposées ou des marques de commerce de leurs propriétaires respectifs.

REMARKS

REMARKS